

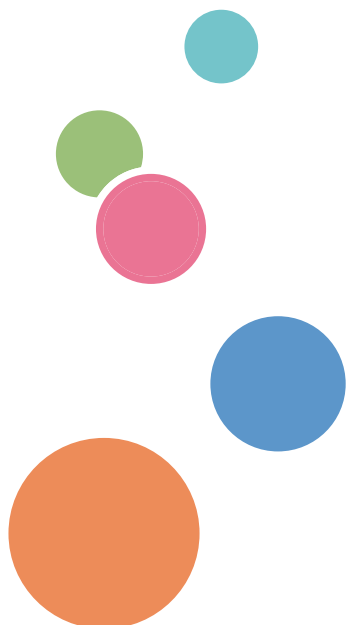

## Operating Instructions





# TABLE OF CONTENTS

---

Notice.....	8
Important.....	8
User's Notes.....	8
How to Read This Manual.....	11
Symbols.....	11
Notes.....	11
Model-Specific Information.....	12
Presentation of the Product Names in This Manual.....	12
<b>1. About This Product</b>	
Guide to Components.....	15
Front View.....	15
Left Side View.....	16
Tray (A4 Standard Tray).....	17
Tray (A5 Tray).....	18
Tray (Sleeve & Socks Tray).....	18
Control Panel.....	20
Loading and Removing the Tray.....	22
Tray Type.....	22
Loading the Tray.....	22
Removing the Tray.....	23
Turning On/Off the Power.....	24
<b>2. Preparing for Printing</b>	
Setup Procedure.....	27
Checking the Computer and Installation Area.....	28
The area where the machine is to be placed.....	28
Checking the power source.....	30
Checking the Computer to be Connected.....	31
Checking the Supplied Items and Unpacking the Machine.....	32
Installing the Ink Cartridges.....	35
Plugging in the Power Cord and Turning the Power On.....	38
Connecting the Computer and Installing the Printer Driver.....	42
Connecting the Computer and Installing the Software (USB Connection).....	43
Connecting the Machine via USB.....	43

---

Installing the Printer Driver.....	44
Sharing the Printer.....	48
Connecting the Computer and Installing the Software (Network Connection).....	50
Connecting the Machine via Ethernet Interface.....	50
Network Settings for Ethernet and Wireless LAN.....	52
Connecting the Machine via a Wireless LAN Interface.....	53
Installing the Printer Driver.....	62
Installing the Printer Driver Manually Using the Network.....	64
Fabric.....	70
Usable Fabric.....	70
Precautions Regarding Fabric.....	70
Loading Fabrics.....	72
Loading a Fabric in the Standard Tray.....	72
Loading Socks in the Sleeve & Socks Tray.....	75
Loading a Sleeve in the Sleeve & Socks Tray.....	78

### **3. Printing on T-shirts**

---

About Design Software.....	83
Operating Environment.....	83
Installing.....	83
Launching.....	84
Exiting.....	84
Creation Flow.....	85
Removing Dust and Flattening Fibers.....	87
Loading a T-shirt in the Tray.....	88
Printing.....	89
Removing the T-shirt from the Tray.....	92
Fixing Ink.....	94
Handling Printed Goods.....	95
Precautions When Washing Printed Goods.....	95

### **4. Printing via the Printer Driver**

---

Setting the Accessories Tab on the Printer Driver.....	97
Printing.....	98
Displaying the Printing Settings.....	99

---

Canceling Printing.....	100
Canceling Printing from the Status Monitor.....	100
Canceling Printing Using the [Stop] Key.....	100
Canceling Printing from the Taskbar.....	101

## 5. Machine Setup Menus

---

Making Machine Settings Using the Control Panel.....	103
Using the [Counter] Menu.....	108
Displaying the Counter.....	109
Printing the Counter.....	110
Differences Between the Counter and the Total Counter.....	110
Using the [List/Test Print] Menu.....	111
Printing a Configuration Page.....	111
Interpreting the Configuration Page.....	112
Using the [Maintenance] Menu.....	113
Nozzle Check.....	114
Head-cleaning.....	116
Head-flushing.....	118
Head Position.....	119
Registration.....	122
Setting the Date and Time.....	125
Move Print-Heads.....	127
Clean Maint Unit.....	129
Auto Head Maint.....	132
Clean Internals.....	133
Using the [System] Menu.....	137
Changing the [System] Menu.....	138
Using the [Host Interface] Menu.....	140
Changing the [Host Interface] Menu.....	144
Precautions to Take When Using in a Network.....	145
Using the [Language] Menu.....	146

## 6. Monitoring and Configuring the Machine

---

Using the Status Monitor.....	147
Using Web Image Monitor.....	148

---

Displaying Top Page.....	148
Menu.....	150
Logging in Using Web Image Monitor.....	150
Changing the Machine Settings.....	151
Notifying the Machine Status by E-mail.....	155
About the Web Image Monitor Help.....	161
SNMP.....	163

## 7. Using the Machine with a Macintosh

---

System Requirements for Macintosh.....	165
Instructions Applicable to Both Macintosh and Windows Computers.....	166
Installing the Printer Driver on a Macintosh.....	168
Adding the Printer through a USB Connection via the Printers & Scanners Preferences Pane.....	168
Adding the Printer in the Printers & Scanners Panel Using Bonjour.....	169
Adding the Printer through a Network Connection via the Printers & Scanners Preferences Pane....	169
Maintenance of the Machine Using a Macintosh.....	171
Displaying the [Maintenance Utility] on a Macintosh.....	171
Printing with a Macintosh.....	172
Canceling Printing on a Macintosh.....	174
Canceling a Print Job from the Print Job Queue Window.....	174
Opening Help on a Macintosh.....	175

## 8. Maintenance

---

Restricting Machine Functions.....	177
Locking the Keys.....	177
Unlocking the Keys.....	177
Replacing an Ink Cartridge.....	178
Checking the Remaining Ink.....	178
Replacing an Ink Cartridge.....	179
Handling Ink Cartridges.....	182
Replacing an Ink Collector Unit.....	184
Checking the Waste Ink Level.....	184
Replacing an Ink Collector Unit.....	185
Replacing Filters.....	188
Adjusting the Fan Speed.....	189

---

Cleaning.....	190
Cleaning the Top Cover.....	190
Cleaning the Height Position Sensor.....	191
Cleaning the Power Cable Plug.....	194
Moving.....	195
Moving a Short Distance.....	195
Moving a Long Distance.....	196
Disposing.....	197
When Not Using for a Long Period of Time.....	198

## 9. Troubleshooting

---

Software Cannot Be Installed.....	199
Confirming Installation.....	199
Checking Your Computer Environment.....	199
Printer Driver Cannot Be Installed.....	201
USB Connection is not Automatically Detected.....	201
If Test Print Fails.....	202
Uninstalling.....	203
Uninstalling the Printer Driver.....	203
Deleting Devices.....	204
Printing Does Not Start.....	205
The Tray Does Not Operate Correctly.....	207
Checking the Status of the Fabric and the Tray.....	207
Adjusting the Height of the Tray.....	208
Removing the Tray Manually.....	212
Removing a Fabric or Foreign Object by Opening the Top Cover.....	212
Print Results Are Not Satisfactory.....	215
Prints are Unsatisfactory.....	215
Colors Do Not Match the Displayed Image.....	218
Positions Do Not Match the Displayed Image.....	219
Other Problems.....	220
Checking the Consumables.....	221
If a Message Appears during Installation.....	222
Error & Status Messages on the Display.....	223

---

Status Messages.....	223
Error Messages.....	223
Status Monitor Errors.....	229
Status Monitor Does Not Open.....	229
No Response from Machine.....	229
No Tray.....	230
Garment Misfeed.....	230
Garment Size Mismatch.....	230
Cover Open.....	230
Print Cartridge(s) Not Detected/Wrong Cartridge/Cover Open.....	231
Cartridge Almost Empty.....	233
Cartridge Empty.....	233
Used Cartridge.....	233
Ink Collector Unit Not Detected/Wrong Unit.....	234
Ink Collector Unit Almost Full.....	235
Ink Collector Unit Full.....	235
Used Ink Collector Unit.....	235
Out of Printable Temperature Range.....	235
Printer Error.....	236
Network Interface Error.....	236
Maintenance Failed.....	236
Cannot Recover Error Page.....	237

## 10. Appendix

---

Software on the CD-ROM.....	239
Files.....	239
RPCS Raster Printer Drivers.....	239
Manuals.....	240
Electromagnetic Interference.....	241
Specifications.....	242
Machine Body.....	242
Optional Trays.....	245
Where to Inquire.....	247
Recommended Consumables.....	248



---

Options and Consumables.....	249
Trademarks.....	250
<b>INDEX</b> .....	253

---

# Notice

---

## Important

---

In no event will the company be liable for direct, indirect, special, incidental, or consequential damages as a result of handling or operating the machine.

For good output quality, the manufacturer recommends that you use genuine ink from the manufacturer.

The manufacturer shall not be responsible for any damage or expense that might result from the use of parts other than genuine parts from the manufacturer with your office products.

---

## User's Notes

---

- High temperatures inside the machine can cause a breakdown. Do not lean anything against the vent or block it in any way.

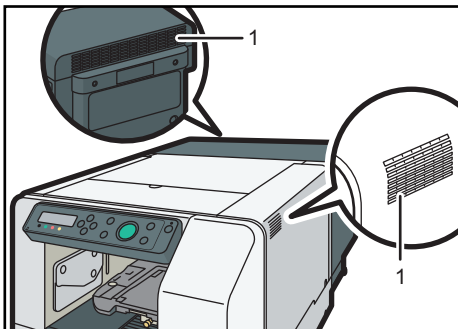

DYX002

### 1. Vent

- Warm air from the vent is normal and not a cause for concern.
- Do not leave the top or right front cover open. If you do, dust or other matter might get inside the machine, and this will reduce print quality.
- During printing, do not move the machine or open its covers.
- Do not open the top or right front cover during printing. If you do, printing will stop.
- Do not touch ink tubes or toothed rubber belt. Also, take care not to catch cables or ink tubes with your sleeves.

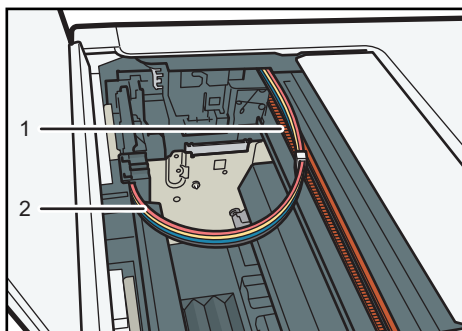

**1. Toothed rubber belt**

**2. Ink tubes**

- Take care not to drop foreign objects inside the machine.
- After you install the ink cartridge and turn the machine on for the first time, the print head priming process will begin. This process sometimes clogs the print head. If this happens, perform the head cleaning procedure.
- During printing, do not turn off the power or unplug the power cord from the wall outlet.
- During printing, do not subject the machine to external shock.
- When not using the machine, turn off the power.
- You can place up to 10 kg (22.1 lb.) of evenly spread weight on the machine. Do not place any concentrated weight of more than 2.5 kg (5.6 lb.) on the machine.
- Do not place unsteady objects on the machine. If they fall, they will cause injury to users and/or damage to the machine.
- "Pages Printed" displays the number of pages printed. Use "Pages Printed" to estimate the number of pages that can be printed within the machine's remaining operational life. The machine's operational life is calculated based on the number of pages that it can print in [Speed] mode.
- Depending on your printing document, the ink collector unit may fill up sooner than normal. "Prepare new Ink Collector Unit" message appears shortly before the ink collector unit is full. Although the machine remains usable until the unit is completely full, contact your sales or service representative as early as possible (charge incurred).
- Ink cartridges should be used up before their expiry date, ideally within six months of being removed from their packaging.
- Cartridges that are no longer usable for printing reserve a small quantity of ink for maintenance usage.
- Ink cartridges and supplies comply with the manufacturer's safety specifications. To ensure safety and reliability, use genuine ink cartridges and supplies.
- Printing hundreds of copies in a single day might cause the print head to clog the following day. If this happens, perform the head cleaning procedure.

- 
- This machine performs regular automatic maintenance, after and during printing, to ensure consistent print quality. Maintenance is also performed when printing begins after a period of disuse.
  - Color ink may be used even if you print all-black text or if you specify black and white printing. It may also be used for print head cleaning and refreshing, which are done to maintain machine performance.
  - If the machine will not be used for a long time, turn its power off, disconnect the USB cable or Ethernet cable, and unplug the power cord from the wall outlet. If you do not use the machine for three months or longer, clean the internal compartments using the dedicated cleaning cartridge in advance. For the cleaning method, see page 133 "Clean Internals". Because the machine consumes a lot of ink for maintenance and print head cleaning when turned on after a long period of inactivity, we recommend you use the machine at least once a month.
  - Do not move the machine while it is powered. Even when it is off, make sure the machine is on a level surface and safe from shock and vibration.
  - Do not turn the machine off while it is busy. Make sure the machine is idle before turning it off.

---

# How to Read This Manual

Be sure to read this section before anything else.

This guide uses Windows 7 procedures for its examples. Procedures and screens might vary depending on the operating system you are using.

---

## Symbols

---

This manual uses the following symbols:

 **Important**

Indicates points to pay attention to when using the functions. As this also includes points which may cause loss of data, be sure to read these explanations.

 **Note**

Indicates supplementary explanations of the machine's functions, and instructions on resolving user errors.

[ ]

Indicates the names of keys on the machine's display or control panels.

 **Region A** (mainly Europe, Asia, and China)

 **Region B** (mainly North America)

Differences in the functions of Region A and Region B models are indicated by two symbols. Read the information indicated by the symbol that corresponds to the region of the model you are using. For details about which symbol corresponds to the model you are using, see page 12 "Model-Specific Information".

---

## Notes

---

Contents of this manual are subject to change without prior notice.

The color samples in this manual may differ slightly from the colors of actual copies.

Some illustrations in this manual might be slightly different from the machine.

Certain options might not be available in some countries. For details, please contact your local dealer.

Depending on which country you are in, certain units may be optional. For details, please contact your local dealer.

---

# Model-Specific Information

This section explains how you can identify the region your machine belongs to.

There is a label on the rear of the machine, located in the position shown below. The label contains details that identify the region your machine belongs to. Read the label.

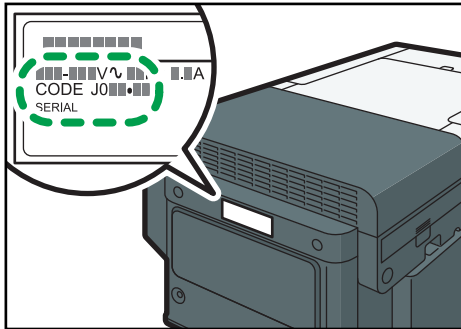

The following information is region-specific. Read the information under the symbol that corresponds to the region of your machine.

 **Region A** (mainly Europe, Asia, and China)

If the label contains the following, your machine is a region A model:

- CODE XXXX -21, -27, -29
- 220-240 V

 **Region B** (mainly North America)

If the label contains the following, your machine is a region B model:

- CODE XXXX -17
- 100-120 V

 **Note**

- Dimensions in this manual are given in two units of measure: metric and inch. If your machine is a Region A model, refer to the metric units. If your machine is a Region B model, refer to the inch units.

---

## Presentation of the Product Names in This Manual

---

This section describes the abbreviations of the standard products and options in this manual.

Product name	Abbreviation
RICOH Tray for Standard Size Type 1	A4 standard tray

Product name	Abbreviation
RICOH Tray for Small Size Type 1	A5 tray
RICOH Tray for Sleeve & Socks Type 1	Sleeve & Socks Tray
RICOH Rh 100	Finisher
RICOH Garment Ink Cartridge K Type 1	Ink cartridge - Black
RICOH Garment Ink Cartridge C Type 1	Ink cartridge - Cyan
RICOH Garment Ink Cartridge M Type 1	Ink cartridge - Magenta
RICOH Garment Ink Cartridge Y Type 1	Ink cartridge - Yellow
RICOH Garment Ink Cartridge K (Hi Yield) Type 1	Ink cartridge - Black
RICOH Garment Ink Cartridge C (Hi Yield) Type 1	Ink cartridge - Cyan
RICOH Garment Ink Cartridge M (Hi Yield) Type 1	Ink cartridge - Magenta
RICOH Garment Ink Cartridge Y (Hi Yield) Type 1	Ink cartridge - Yellow
RICOH Ink Collection Unit Type 1	Ink collector unit
RICOH Cleaning Liquid Type 1	Cleaning liquid
RICOH Cleaning Cartridge K Type 1	Cleaning cartridge
RICOH Cleaning Cartridge C Type 1	Cleaning cartridge
RICOH Cleaning Cartridge M Type 1	Cleaning cartridge
RICOH Cleaning Cartridge Y Type 1	Cleaning cartridge
RICOH Cleaning Tool Type 1	Cleaning tool
RICOH Cleaning Absorber Type 1	Absorbent
RICOH Cleaning Stick Type 1	Cleaning stick
RICOH Fan Filter Type 1	Filter
RICOH Design Software	Design Software





# 1. About This Product

This chapter describes the names and functions of the machine's parts and options.

## Guide to Components

### Front View

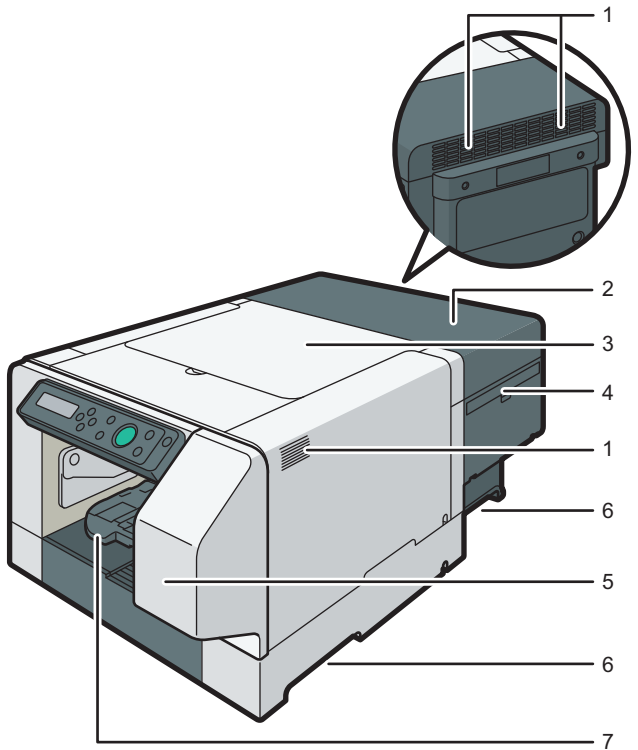

DSB065

#### 1. Vent

Air is vented here to prevent the inside of the machine from getting too warm. Do not lean anything against the vent or block it in any way. If the inside of the machine gets too warm, a breakdown could occur.

#### 2. Rear Cover

#### 3. Top Cover

Normally, keep this cover closed. For safety reasons, opening or closing the top cover will cause the power to turn off immediately. Do not open or close the top cover when not required, such as while printing is performed. When a message prompting you to open the top cover appears on the display, follow the instructions.

**4. Filter**

If a message prompting you to replace the filter appears, replace it.

**5. Right Front Cover**

Normally, keep this cover closed. Open this cover only when you need to install or replace an ink cartridge or replace the ink collector unit.

**6. Indentations for Lifting**

**7. Tray Stand**

Stand for setting the tray.

---

**Left Side View**

---

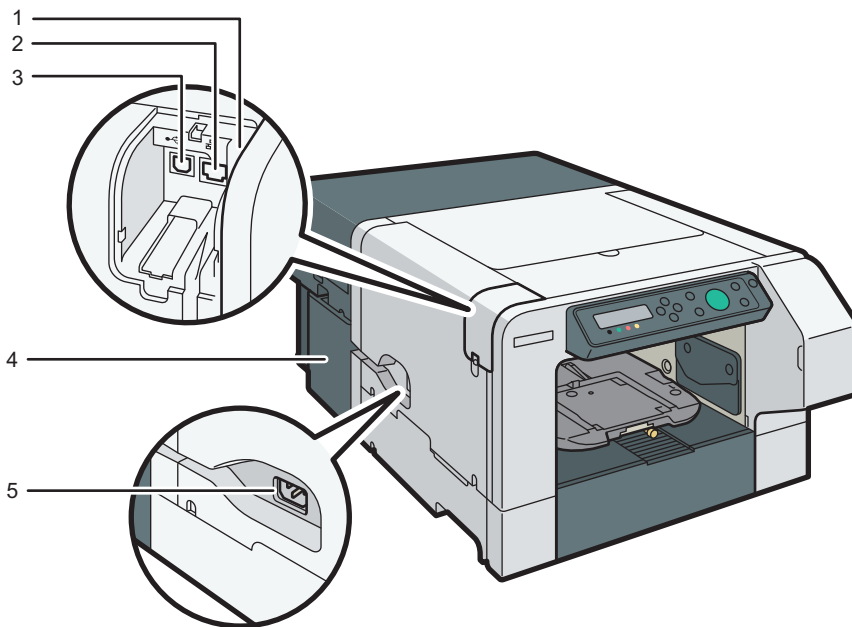

DSB066

**1. Wireless LAN cable**

Connect this to the Ethernet port if you are accessing the machine via wireless LAN.

**2. Ethernet port**

Port for connecting the 100BASE-TX or 10BASE-T cable.

**3. USB port**

Port for connecting the USB2.0 interface cable.

**4. Power cover**

A cover to protect the power cord.

**5. Power inlet**

Plug the power cord.

## Manual Pocket

Set the "User's Guide" supplied with this machine.

### Installing the Manual Pocket

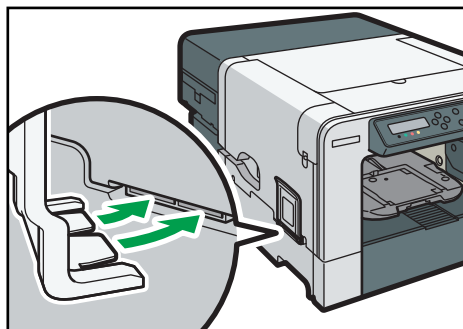

DYX011

1

## Tray (A4 Standard Tray)

You can print within an A4 size (210 × 297 mm) (8.3 × 11.7 inches) area on a garment using this tray.

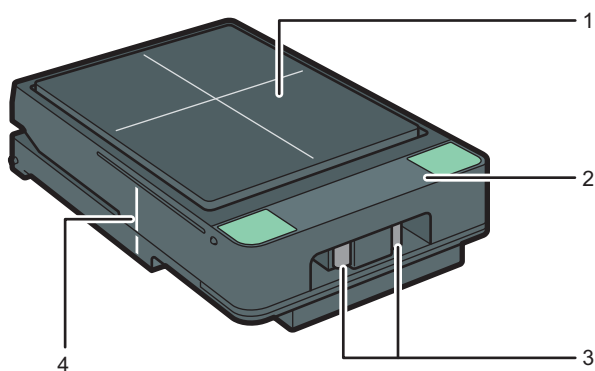

DSA108

### 1. Table

A stand for setting fabrics.

### 2. Cover

Open the cover when setting fabrics on the table.

### 3. Unlock Button

Press to unlock and open the cover.

### 4. Tray Positioning Line

Align this line with the edge of the machine when installing the tray.

---

## Tray (A5 Tray)

---

You can print within an A5 size (148 × 210 mm) (5.9 × 8.3 inches) area on a garment using this tray.

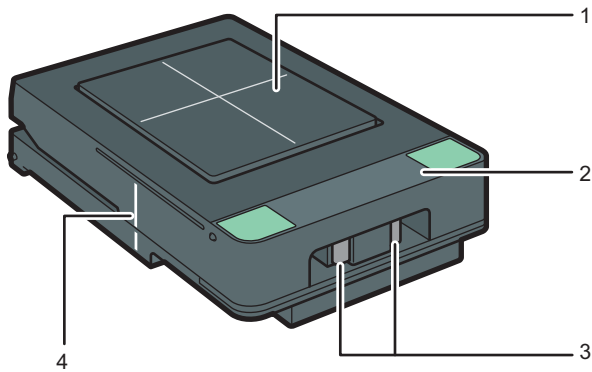

DSA109

### 1. Table

A stand for setting fabrics.

### 2. Cover

Open the cover when setting fabrics on the table.

### 3. Unlock Button

Press to unlock and open the cover.

### 4. Tray Positioning Line

Align this line with the edge of the machine when installing the tray.

---

## Tray (Sleeve & Socks Tray)

---

You can print sleeve or socks using this tray.

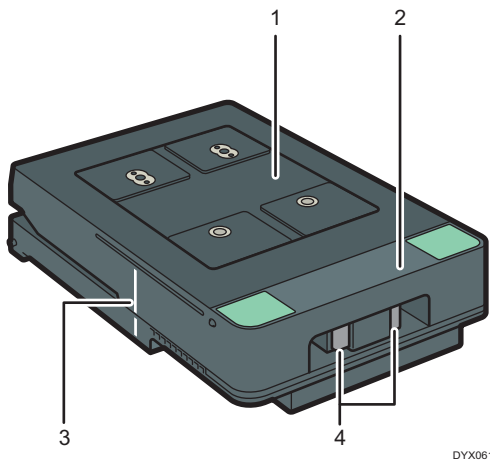

DYX061

**1. Table**

A stand for setting fabrics.

**2. Cover**

Open the cover when setting fabrics on the table.

**3. Tray Positioning Line**

Align this line with the edge of the machine when installing the tray.

**4. Unlock Button**

Press to unlock and open the cover.

# Control Panel

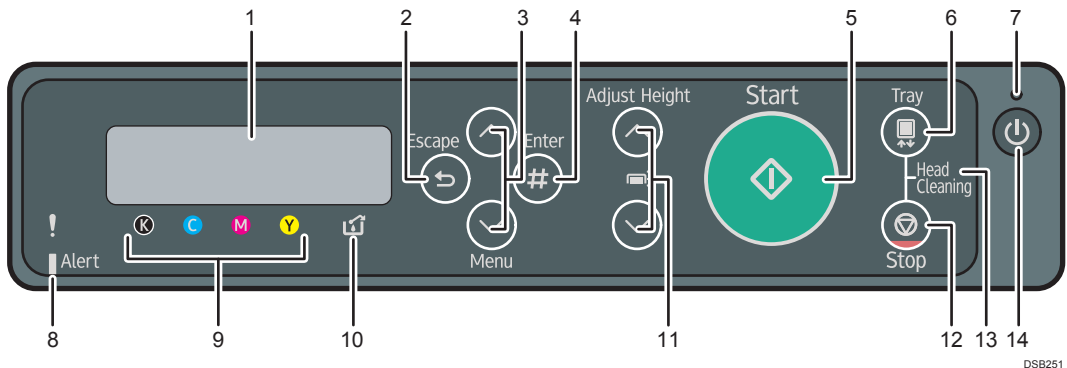

## 1. Display

Displays the current machine status and messages.

## 2. [Escape] key

Press this key to return to the previous condition on the display.

## 3. [▲], [▼/Menu] keys

Use these keys to increase or decrease values on the display when making settings.

Keep the key pressed to quicken scrolling, and increase or decrease values on the display in units of 10.

To apply this function: under [Maintenance], set [Key Repeat] to [On].

See page 113 "Using the [Maintenance] Menu".

When the machine is in standby mode, press the [▼/Menu] key to make and check the current machine settings.

## 4. [#Enter] key

Press this key to execute menu items selected on the display.

## 5. [Start] key

Start printing. LED of the [Start] key lights up when the machine is ready to start printing and flashes when it is printing.

## 6. [Tray] key

Press this key to move the tray forcibly to the front.

## 7. Power lamp

Lights up when the power is on.

Flashes when the machine is receiving data from a computer or if there is data to be printed.

## 8. Alert indicator

Lights up or blinks whenever a machine error occurs.

If the red light is on, follow the instructions that appear on the display.

See page 223 "Error & Status Messages on the Display".

## 9. Cartridge replacement indicator

Each color corresponds to an ink cartridge.

K, C, M, and Y indicate black, cyan, magenta, and yellow, respectively.

The amount of ink remaining in each ink cartridge is indicated on the six-level display.

## 10. Waste ink full indicator

The amount of waste ink is indicated on the six-level display. A message appears when it is time to replace the ink collector unit.

## 11. [Adjust Height ▲], [Adjust Height ▼] keys

Move the height of the tray up and down to adjust the height.

Holding down the key, you can adjust the height of the tray quickly. To apply this function, set [Key Repeat] to [On]. See page 113 "Using the [Maintenance] Menu".

## 12. [Stop] key

When the machine is online, press this key to cancel an ongoing print job.

## 13. No-Fuss Head Cleaning

When the machine is in standby mode, press the [Stop] and [Tray] keys at the same time to perform head cleaning for all colors.

## 14. [Power] key

Press this key to turn the power on. To turn the power off, press and hold down this key for one second.

See page 24 "Turning On/Off the Power".

# Loading and Removing the Tray

---

1

## Tray Type

---

The following three types of trays can be used with this machine.

For fabrics that can be used for each tray, see page 70 "Usable Fabric".

- A4 standard tray

Use this tray when printing within an A4 size area on a fabric.

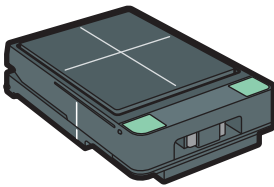

DSA334

- A5 tray

Use this tray when printing within an A5 size area on a fabric.

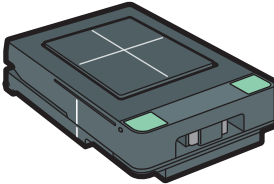

DSA335

- Sleeve & Socks Tray

Use this tray when printing on sleeve or socks.

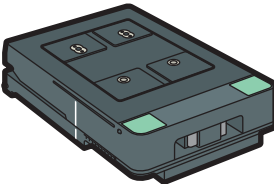

DYX062

---

## Loading the Tray

---

Place the rear side of the tray on the tray stand, and then slowly push it in all the way until you hear it click. When the tray positioning line matches the edge of the machine, the tray is correctly loaded.



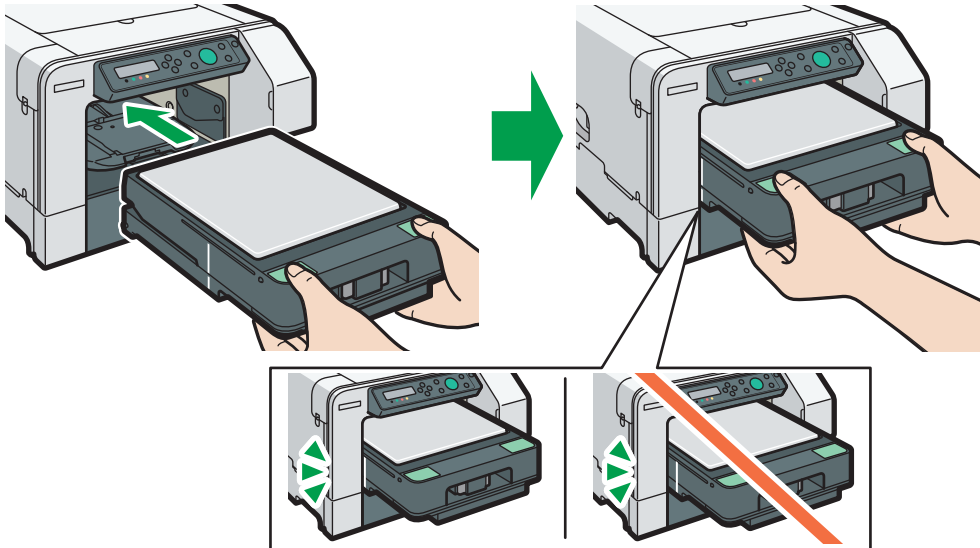

DSA063

## Removing the Tray

After printing is completed, remove the tray once it returns and stops at the position so that you can see the tray positioning line on the left side of the tray.

When the [Start] key is lit up, printing has not yet completed. Press the [Start] key again without removing or moving the tray from the machine. Printing starts again.



DSA005

When using the A4 standard tray or A5 tray, insert the protection cover horizontally as illustrated in the figure, and then remove it with the A4 standard tray or A5 tray. This prevents you from coming into contact with the printing surface. Make sure the protection cover is correctly positioned horizontally.

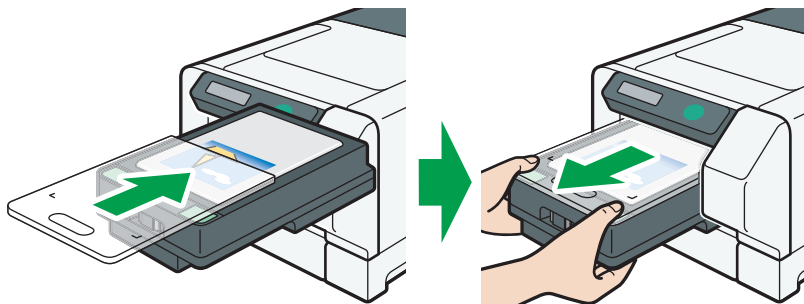

DYG008

# Turning On/Off the Power

## ★ Important

- When you turn the machine off, make sure you press and hold down the [Power] key. If you unplug the Power cord from the wall outlet, ink consumption for maintenance operations may increase.

### Turning on the power

1. Press the [Power] key.

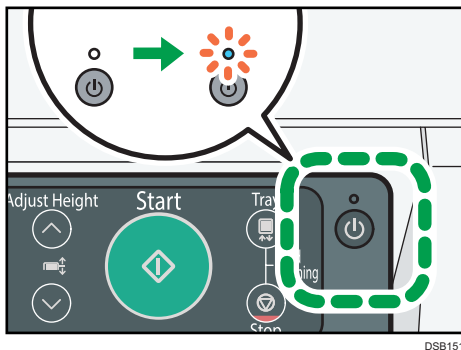

If the machine starts warming up, the power lamp flashes and the "Waiting..." message will be displayed.

If the machine becomes printable, the power lamp lights and the "Ready" message will be displayed.

### Turning off the power

1. Press and hold down the [Power] key for one second.

When the machine is in shutdown mode, the "Shutting down..." message is displayed.

When the machine stops, the power lamp and the display turn off.

## ↓ Note

- To cut electricity consumption completely, press the [Power] key for one second, and check that the power lamp is turned off. Then, unplug the power cord from the wall outlet.
- When switching off the energy saving power strip (power strip with a switch), be sure to turn off the machine before following the above procedures.
- Energy Saver mode is available for this machine. If you do not use this machine for a specified time after turning it on, the machine will be in Energy Saver mode automatically, and electricity consumption of the machine will be reduced. To specify a wait period for Energy Saver mode initiation, configure the system settings. See page 137 "Using the [System] Menu".
- If the machine is in Energy Saver mode, the display turns off.

- The machine recovers from Energy Saver mode when it receives a print job, or when any key is pressed.



# 2. Preparing for Printing

This chapter describes installation and setup procedures.

## Setup Procedure

This section explains the tasks necessary for printing.

Install and set up the machine by following the steps in the order shown.

Step	Task	Reference for Full Details
1	Check the installation environment.	page 28 "Checking the Computer and Installation Area"
2	Check the supplied items.	page 32 "Checking the Supplied Items and Unpacking the Machine"
3	Install the ink cartridges.	page 35 "Installing the Ink Cartridges"
4	Plug in the power cord and turn on the power, and then supply ink to the machine.	page 38 "Plugging in the Power Cord and Turning the Power On"
5	Load a fabric.	page 72 "Loading Fabrics"
6	Perform a test print.	page 111 "Printing a Configuration Page"
7	Connect the machine and computer and install the software using "Quick Install".	page 43 "Connecting the Computer and Installing the Software (USB Connection)" page 50 "Connecting the Computer and Installing the Software (Network Connection)" If you are using a Macintosh, see page 165 "Using the Machine with a Macintosh".

# Checking the Computer and Installation Area

The machine's location should be carefully chosen because environmental conditions greatly affect its performance.

## The area where the machine is to be placed

### **WARNING**

- Do not use flammable sprays or solvents in the vicinity of this machine. Also, avoid placing these items in the vicinity of this machine. Doing so could result in fire or electric shock.
- Do not place vases, plant pots, cups, toiletries, medicines, small metal objects, or containers holding water or any other liquids, on or close to this machine. Fire or electric shock could result from spillage or if such objects or substances fall inside this machine.
- Be sure to locate the machine as close as possible to a wall outlet. This will allow easy disconnection of the power cord in the event of an emergency.

### **CAUTION**

- Keep the machine away from humidity and dust. Otherwise a fire or an electric shock might occur.
- Do not place the machine on an unstable or tilted surface. If it topples over, an injury might occur.
- Do not place heavy objects on the machine. Doing so can cause the machine to topple over, possibly resulting in injury.
- Do not obstruct the machine's vents. Doing so risks fire caused by overheated internal components.
- Make sure the room where you are using the machine is well ventilated and spacious. Good ventilation is especially important when the machine is used heavily.

### **Important**

- To avoid malfunctions, position the machine away from the following:
  - direct sunlight
  - flow of air from air conditioners or heaters
  - radios, televisions, or other electronic devices

- areas of high/low temperature and high/low moisture
- humidifying appliances
- oil stoves and ammonia-emitting appliances (such as diazo copiers)
- Do not place the machine on an unstable surface. The vibration of the machine could deteriorate the print quality. Place the machine on a stable surface.

Choose a flat, stable area to install the machine.

- The surface should be level within two degrees, left to right and front to back.
- To prevent condensation, install the machine in an area where temperature and humidity conditions do not exceed those indicated in the diagram below.
- The machine may cease to print if these limitations are exceeded.

 **Region A** (mainly Europe, Asia, and China)

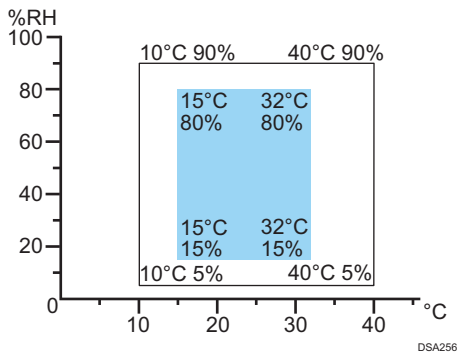

 **Region B** (mainly North America)

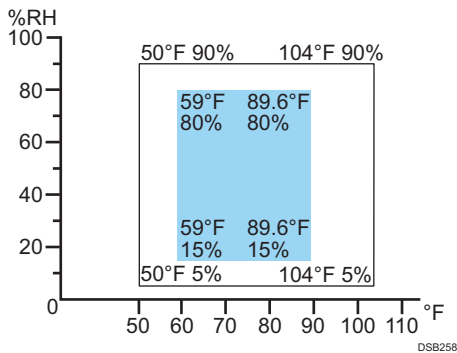

- White area: Operation range (Although operations are possible within this range, image quality is not guaranteed.)
- Blue area: recommended range
- Secure the space indicated in the following figure in order to smoothly load fabrics and replace ink cartridges.

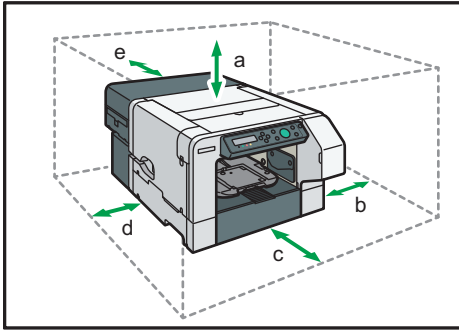

DYX042

- a. 27 cm (10.6 inches)
- b. 10 cm (4.0 inches)
- c. 53 cm (20.9 inches)
- d. 25 cm (9.9 inches)
- e. 10 cm (4.0 inches)

## Checking the power source

### **WARNING**

- Do not use any power sources other than those that match the specifications shown. Doing so could result in fire or electric shock.
- Do not use any frequencies other than those that match the specifications shown. Doing so could result in fire or electric shock.
- Do not use multi-socket adaptors. Doing so could result in fire or electric shock.
- Do not use extension cords. Doing so could result in fire or electric shock.
- Do not use power cords that are damaged, broken, or modified. Also, do not use power cords that have been trapped under heavy objects, pulled hard, or bent severely. Doing so could result in fire or electric shock.
- Touching the prongs of the power cable's plug with anything metallic constitutes a fire and electric shock hazard.
- It is dangerous to handle the power cord plug with wet hands. Doing so could result in electric shock.



**⚠ WARNING**

- The supplied power cord is for use with this machine only. Do not use it with other appliances. Doing so could result in fire or electric shock.
- If the power cord is damaged and its inner wires are exposed or broken, contact your service representative for a replacement. Use of damaged power cords could result in fire or electric shock.
- Be sure to locate the machine as close as possible to a wall outlet. This will allow easy disconnection of the power cord in the event of an emergency.

**⚠ CAUTION**

- Be sure to push the plug of the power cord fully into the wall outlet. Partially inserted plugs create an unstable connection that can result in unsafe buildup of heat.

**🌐 Region A** (mainly Europe, Asia, and China)

## Power Source

220-240V, 0.6A or more, 50/60Hz

Please be sure to connect the power cord to a power source as above.

**🌐 Region B** (mainly North America)

## Power Source

100-120V, 1A or more, 60Hz

Please be sure to connect the power cord to a power source as above.

---

**Checking the Computer to be Connected**

---

To use this machine, computers must meet the following specifications:

- PC/AT-compatible computer with USB or network interface
- Operating system:
  - Microsoft Windows Vista/7/8.1/10
  - Microsoft Windows Server 2008/2008 R2/2012/2012 R2/2016
  - Mac OS X 10.8 and later versions

**↓ Note**

- For the required hard disk free space and amount of memory installed, follow the system requirements of each operating system.

# Checking the Supplied Items and Unpacking the Machine

## **⚠ WARNING**

- The following explains the warning messages on the plastic bag used in this product's packaging.
  - Keep the polythene materials (bags, etc.) supplied with this machine away from babies and small children at all times. Suffocation can result if polythene materials are brought into contact with the mouth or nose.

## **⚠ CAUTION**

- The printer weighs around 24 kg (53.0 lb).
- Hold the lift indentations at the base of the machine's sides with two people or more. Lift it slowly and do not strain your body.
- When moving the machine, be sure to remove the tray and manual pocket. Lifting the machine forcefully or treating it roughly may break it or result in injury.

## **★ Important**

- Do not turn the machine on until you have read how to do so.

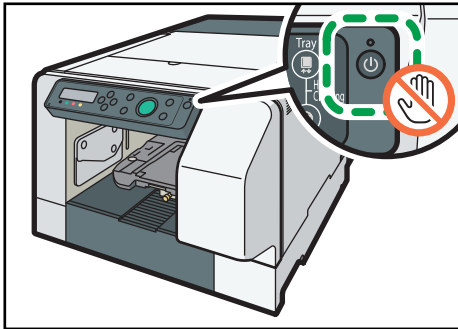

DYX058

### 1. Open the box and take out all supplied items. Check that all the following items are present:

- A4 standard tray
- Protection cover
- Maintenance kit
- Power Cord
- Quick Installation Guide
- Safety Information

- CD-ROM
- User's Guide
- Quick Guide
- Notes for Wireless LAN Users
- Maintenance Guide
- Replacing the Ink Collection Unit Type 1
- Manual Pocket

**2. Take off the protective covering.**

**3. Remove the plastic bag.**

**4. Lift the machine and move it to the place where you want to install it.**

Grip the indentations for lifting at the base of the machine's sides with two people or more, as shown. Lift and carry the machine slowly and carefully.

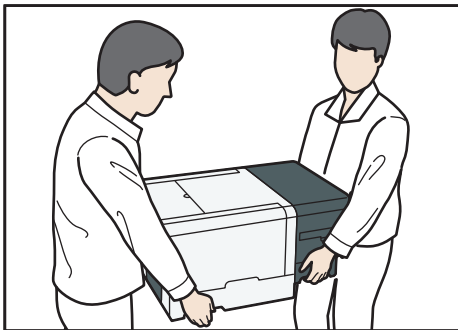

DSB067

**5. Remove all orange adhesive tapes from the machine body.**

**6. Remove the protection cover from the tray.**

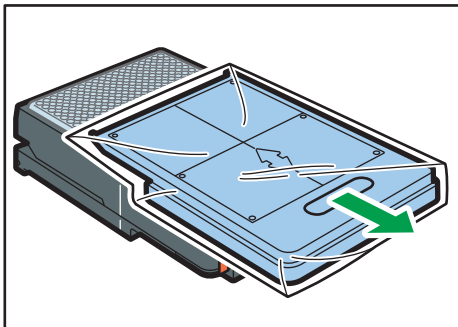

DSA191

**7. Remove the adhesive tape from the tray.**

Remove the adhesive tape partway.

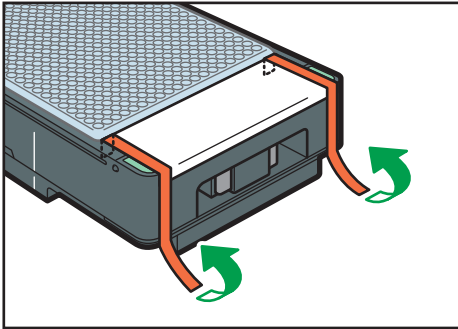

DSA192

Press the unlock button and lift the cover, and then remove the adhesive tape the rest of the way.

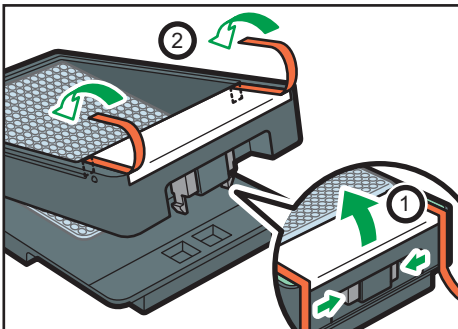

DSA193

**8. Install the manual pocket.**

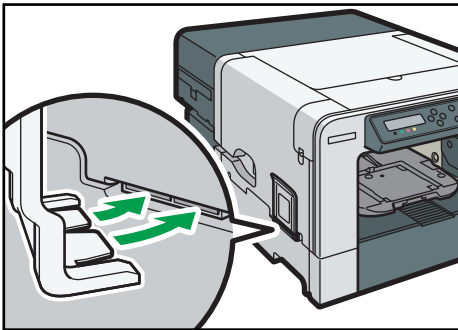

DYX011

**9. Set the "User's Guide" supplied with this machine to the manual pocket.**

**Note**

- We recommend you keep the box, so you can use it again when moving the machine.
- USB and LAN cables are not supplied.

# Installing the Ink Cartridges

## **⚠ CAUTION**

- Keep ink and ink containers out of reach of children.
- If ink gets into contact with eyes, wash eyes immediately with running water. Consult a doctor if necessary.
- When replacing ink, avoid getting ink on your clothing. If ink comes into contact with your clothing, wash the stained area with cold water. Hot water will set the ink into the fabric and make removing the stain impossible.
- When replacing ink, avoid getting ink on your skin. If ink comes into contact with your skin, wash the affected area thoroughly with soap and water.
- When removing the ink cartridge, avoid putting your hand near the place where the ink cartridge is installed. If ink comes in contact with your hands, wash them thoroughly with soap and water.

## **★ Important**

- Some ink is consumed to fill the print heads when you turn on the machine for the first time. Therefore, the number of pages to be printed will be smaller than when normal cartridges are used.
- When installing the ink cartridge, do not touch the inside of the machine.
- Do not turn the machine on until you have read how to do so.

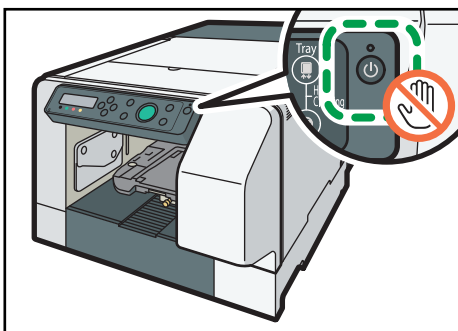

DYX058

- Be sure to install the unused ink cartridge that is genuine. Installing any other cartridge could result in incomplete ink filling and malfunction.

### 1. Remove the packaging from the ink cartridges.

Do not touch the ink supply ports or silicon substrates of ink cartridges.

**2. Open the right front cover.**

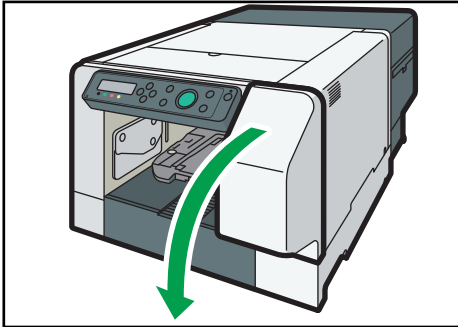

DYX012

**3. Check the orientation of each cartridge, and then install them gently.**

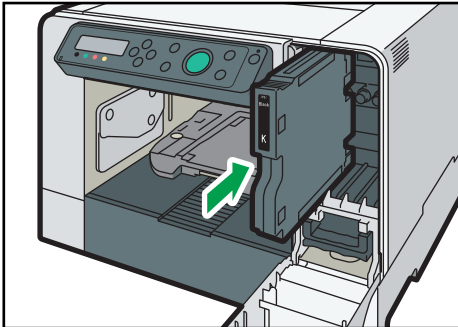

DSA159

Install in the following order from the left: black, cyan, magenta, and yellow.

**4. Push in each cartridge.**

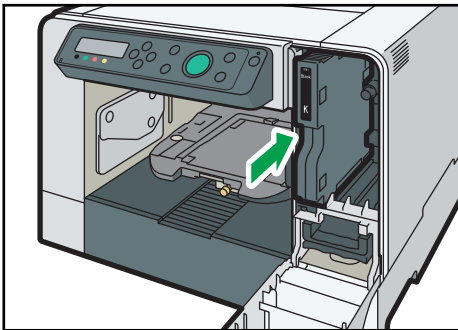

DSA160

**5. Repeat steps 3 to 4 for all four cartridges.**

6. Close the right front cover.

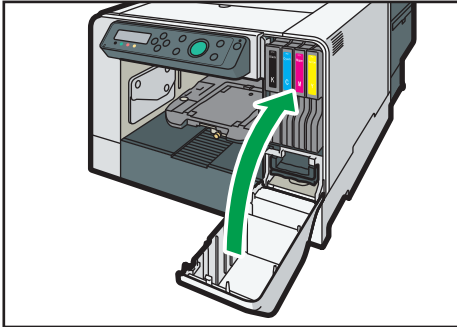

DYX013

# Plugging in the Power Cord and Turning the Power On

Before connecting the machine to a computer, connect the machine's power cord and turn the machine on.

## **WARNING**

- Do not use any power sources other than those that match the specifications shown in this manual. Doing so could result in fire or electric shock.
- Do not use any frequencies other than those that match the specifications shown. Doing so could result in fire or electric shock.
- Do not use multi-socket adaptors. Doing so could result in fire or electric shock.
- Do not use extension cords. Doing so could result in fire or electric shock.
- Do not use power cords that are damaged, broken, or modified. Also, do not use power cords that have been trapped under heavy objects, pulled hard, or bent severely. Doing so could result in fire or electric shock.
- Touching the prongs of the power cable's plug with anything metallic constitutes a fire and electric shock hazard.
- It is dangerous to handle the power cord plug with wet hands. Doing so could result in electric shock.
- The supplied power cord is for use with this machine only. Do not use it with other appliances. Doing so could result in fire or electric shock.
- If the power cord is damaged and its inner wires are exposed or broken, contact your service representative for a replacement. Use of damaged power cords could result in fire or electric shock.
- Be sure to locate the machine as close as possible to a wall outlet. This will allow easy disconnection of the power cord in the event of an emergency.

## **CAUTION**

- Be sure to push the plug of the power cord fully into the wall outlet. Partially inserted plugs create an unstable connection that can result in unsafe buildup of heat.



## CAUTION

- When disconnecting the power cord from the wall outlet, always pull the plug, not the cord. Pulling the cord can damage the power cord. Use of damaged power cords could result in fire or electric shock.

## Important

- Do not handle the machine while the cartridge is being filled.
- Some ink is consumed to fill the print heads when you turn on the machine for the first time.

### 1. Plug the power cord fully into the machine.

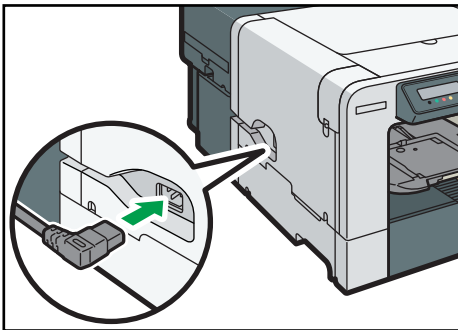

DSB068

### 2. Open the power cover.

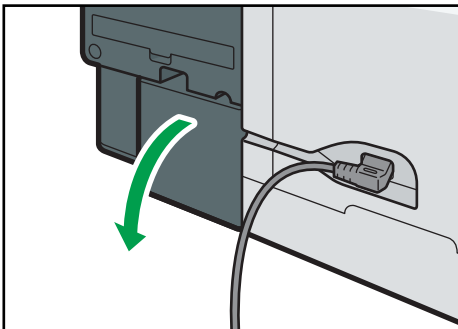

DSB069

3. Set the power cord as shown in the figure, and then close the power cover.

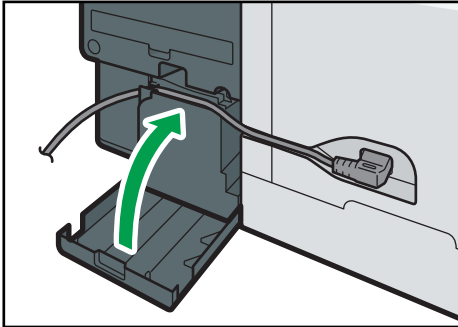

DSB070

4. Plug the power cord fully into the wall outlet.

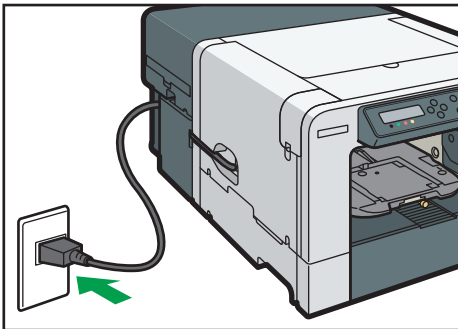

DSB073

The surface should be level within two degrees.

Make sure the power cord is not trapped under the machine.

5. Press the [Power] key.

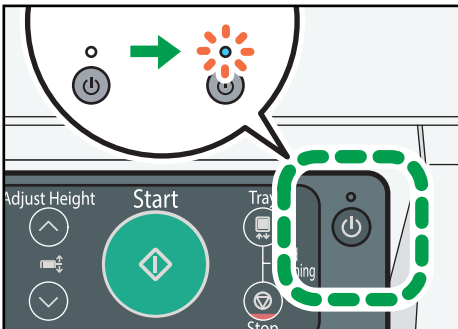

DSB151

The machine starts feeding ink into its print heads.

Leave the machine idle for about seven minutes until the message "Ready" appears.

Do not remove the plug from the wall outlet while the ink is being fed.

You might hear a clicking sound while the print heads are being filled. This is not a malfunction and it will stop after a while.

When the supplying of ink is complete, the power lamp changes from flashing to remaining lit.

# Connecting the Computer and Installing the Printer Driver

The machine has three connection methods: USB, wired, and wireless. Check the flow from connecting the computer to installing the printer driver by looking at the following table:

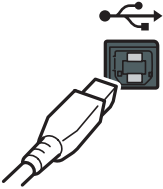
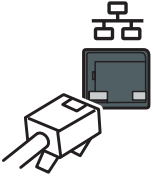
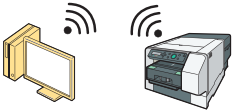
Connection method	Reference for full details
<p data-bbox="299 564 344 589">USB</p> 	<p data-bbox="495 564 1146 629">page 43 "Connecting the Computer and Installing the Software (USB Connection)"</p> <p data-bbox="495 648 968 674">Connect the machine to the computer via USB</p> <p data-bbox="495 693 513 719">↓</p> <p data-bbox="495 738 659 764">Install the driver</p>
<p data-bbox="285 834 353 860">Wired</p> 	<p data-bbox="495 834 1146 899">page 50 "Connecting the Computer and Installing the Software (Network Connection)"</p> <p data-bbox="495 919 1103 944">Connect the machine to the computer via an Ethernet cable</p> <p data-bbox="495 964 513 989">↓</p> <p data-bbox="495 1009 769 1034">Configure network settings</p> <p data-bbox="495 1054 513 1079">↓</p> <p data-bbox="495 1099 659 1125">Install the driver</p>
<p data-bbox="275 1164 363 1189">Wireless</p> 	<p data-bbox="495 1164 1146 1228">page 50 "Connecting the Computer and Installing the Software (Network Connection)"</p> <p data-bbox="495 1248 1103 1274">Connect the machine to the computer via an Ethernet cable</p> <p data-bbox="495 1293 513 1319">↓</p> <p data-bbox="495 1338 769 1364">Configure network settings</p> <p data-bbox="495 1383 513 1409">↓</p> <p data-bbox="495 1428 821 1454">Configure wireless LAN settings</p> <p data-bbox="495 1473 513 1499">↓</p> <p data-bbox="495 1519 659 1544">Install the driver</p>

# Connecting the Computer and Installing the Software (USB Connection)

Connect the machine to the computer via a USB cable. Then, install the printer driver. Finally, configure the network share settings as necessary.

This guide uses Windows 7/10 procedures for its examples. Procedures and screens might vary depending on the operating system you are using.

2

## Connecting the Machine via USB

1. Make sure the machine is off.

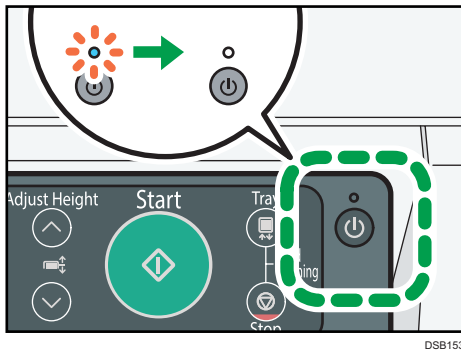

2. Turn on the power of the computer.

Quit all applications currently running.

If the "Add New Hardware Wizard" appears, click [Cancel], and then turn the machine off.

3. Open the port cover.

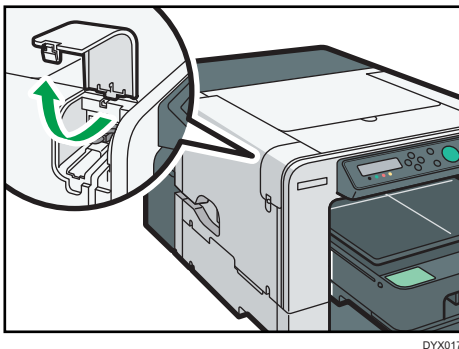

4. Insert the USB cable's hexagonal (type B) plug into the port.

Check the shape and direction of the plug and make sure the cable is fully inserted.

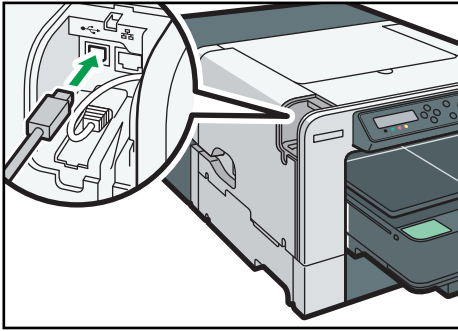

DYX018

**5. Close the port cover.**

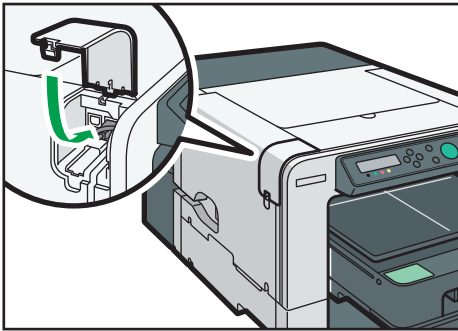

DYX048

**6. Insert the USB cable's rectangular (type A) plug into the computer's USB port.**

Check the shape and direction of the plug and make sure the cable is fully inserted.

**Note**

- When also sharing the machine connected via USB over a network, connect the machine to the computer in accordance with the explanation above. For the share settings, see page 48 "Sharing the Printer".

---

## Installing the Printer Driver

---

Once the machine is connected to the computer, install the printer driver.

There are two installation methods. Install the printer driver using one of these methods.

- **Quick Install for USB**  
Install the printer driver automatically. See page 45 "Quick Install for USB".
- **Manual install**  
Configure the settings of the printer driver manually and install it. See page 46 "Installing the printer driver manually using a USB cable".

**Note**

- When sharing the machine connected via USB over a network, configure the share settings upon installing the printer driver. See page 48 "Sharing the Printer".

**Quick Install for USB**

Follow the procedure below to install the printer driver.

**Important**

- Do not turn the machine on until you have read how to do so.

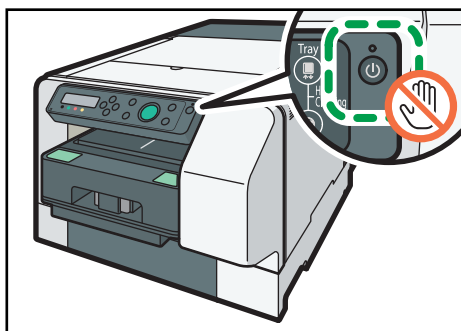

DYY060

- Only administrators can perform this installation. Log on as a member of the Administrators group.

**Notes on the Installation**

- Ignore the Windows security warning if it appears during installation and continue with the installation.
- If the "Add New Hardware Wizard" appears, click [Cancel], and then turn the machine off.

**1. Insert the driver CD in the CD-ROM drive.**

Quit all other applications currently running.

**2. Select a language for the interface, and then click [OK].****3. Click [Quick Install for USB].****4. Read the entire license agreement carefully. If you accept its terms, click [I accept the agreement.], and then click [Next >].****5. Check that the power of the machine is off, and then click [Next >].**

Installation starts.

Ignore the Windows security warning if it appears during installation and continue with the installation.

**6. Make sure that the computer and machine are properly connected, and then press the [Power] key.****7. Click [Yes] to specify the machine as the default printer.**

8. Select whether or not to open the Status Monitor automatically, and then click [Next >].
9. If you want to make initial settings for the printer, click [Set Now].
10. Make initial settings, and then click [OK].
11. Click [Finish].

The printer driver is now installed.

**Note**

- When you insert the CD-ROM, the installer launches. Auto Run might not work automatically with certain OS settings. If this is the case, double-click "SETUP.EXE", located on the CD-ROM root directory, or click [Run SETUP.EXE] in the [AutoPlay] dialog box.
- If a message prompting you to restart the computer appears, restart the computer.
- In order to confirm that the printer driver is correctly installed, check that the power lamp is lit, and then perform a test print. To perform a test print, open the properties of the printer driver and click [Print Test Page] under the [General] tab. If the test page does not print properly, see page 202 "If Test Print Fails".

### Installing the printer driver manually using a USB cable

---

This section explains how to install the printer driver manually by connecting the machine to a computer using a USB cable.

If you installed the printer driver by performing Quick Install for USB, there is no need to install it again.

**Important**

- Only administrators can perform this installation. Log on as a member of the Administrators group.
- Do not turn the machine on until you have read how to do so.

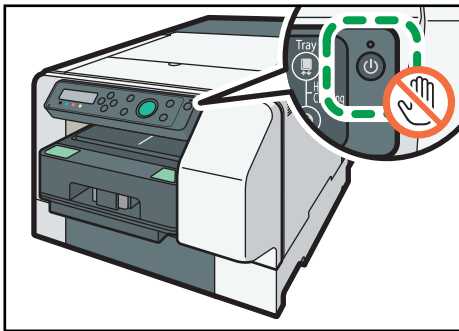

DYX060

1. Insert the driver CD in the CD-ROM drive.

Quit all other applications currently running.

If the "Add New Hardware Wizard" appears, click [Cancel], and then turn the machine off.



When you insert the CD-ROM, the installer launches. Auto Run might not work automatically with certain OS settings. If this is the case, double-click "SETUP.EXE", located on the CD-ROM root directory, or click [Run SETUP.EXE] in the [AutoPlay] dialog box.

If the screen does not appear even when you double-click the [SETUP.EXE] icon, or if an error occurs during the installation, access the CD-ROM drive.

Double-click the [RP\_SETUPXX.EXE] icon in the [DRIVERS] folder, and then install the printer driver by following the instructions that appear on the screen.

2. Select a language for the interface, and then click [OK].
3. Click [Printer Driver].
4. Read the entire license agreement carefully. If you accept its terms, click [I accept the agreement.], and then click [Next >].
5. Click [Connect USB cable], and then click [Next >].
6. Check that the power of the machine is off, and then click [Next >].

Installation starts.

Ignore the Windows security warning if it appears during installation and continue with the installation.

7. Make sure that the computer and machine are properly connected, and then press the [Power] key.

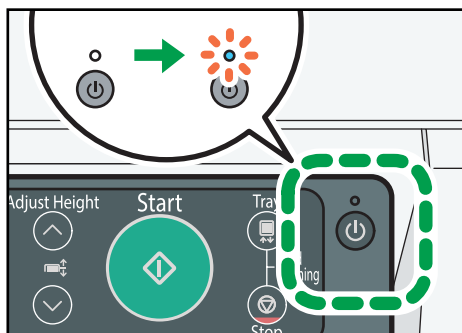

DSB151

8. Click [Yes] to specify the machine as the default printer.
9. Select whether or not to open the Status Monitor automatically, and then click [Next >].
10. If you want to make initial settings for the printer, click [Set Now].
11. Make initial settings, and then click [OK].
12. Click [Finish].

If a dialog box asking whether you want to restart now appears, select [Yes, restart now.], and then click [Finish].

#### ↓ Note

- For details about sharing the printer, see page 48 "Sharing the Printer".

- Confirm the printer driver is correctly installed by checking the Power lamp is lit, and then performing a test print. To perform a test print, open the [Printer Properties] dialog box, click [Print Test Page] on the [General] tab. If the test page does not print properly, see page 202 "If Test Print Fails".
- If Windows Firewall is installed on the print server, configure exceptions in the firewall before using Status Monitor. For details about configuring the Windows Firewall settings, see page 229 "Status Monitor Does Not Open".

## Sharing the Printer

This section explains how to share the printer over a network by connecting it via USB. To share the printer, specify the settings for sharing it on the computer that it is connected to so that the computer acts as a print server.

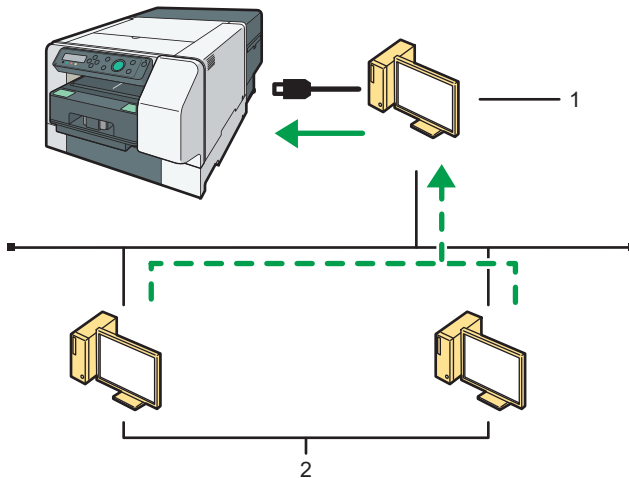

DYX050

1. Server
2. Client computer

## Setting up a server

### ★ Important

- Only administrators can make this setting. Log on as a member of the Administrators group.
1. On the [Start] menu, click [Control Panel].
    - For Windows 10: Right-click the [Start] button, and then click [Control Panel].
  2. Click [Network and Internet].
  3. Click [Network and Sharing Center].

4. Click [Change advanced sharing settings].
5. Click the chevron  to expand [Home or Work (current profile)].
6. In [File and printer sharing], click [Turn on file and printer sharing].
7. Click [Save changes].
8. On the [Start] menu, click [Devices and Printers].
  - For Windows 10: Right-click the [Start] button, and then click [Control Panel]. Once the [Control Panel] window is displayed, click [View devices and printers].
9. Right-click the machine you want to share, and then click [Printer properties].
10. Click the [Sharing] tab, and select the [Share this printer] check box.
11. Click [OK].

Configure a computer connected to the network, where the print server is connected, as a client computer. See page 68 "Using as the Windows network printer".

# Connecting the Computer and Installing the Software (Network Connection)

Connect the machine to the computer via an Ethernet cable or wireless LAN. Then, configure the network settings in accordance with the network environment. Finally, install the printer driver.

This guide uses Windows 7/10 procedures for its examples. Procedures and screens might vary depending on the operating system you are using.

**★ Important**

- A wired connection and wireless LAN connection cannot be used simultaneously.

---

## Connecting the Machine via Ethernet Interface

---

Be sure to install all necessary network equipment, such as hubs, etc. before connecting the Ethernet cable to the machine.

You can connect a 10BASE-T or 100BASE-TX cable to the machine.

**★ Important**

- Ethernet cables are not supplied with this machine. Select your cable according to the network environment.

1. Open the port cover.

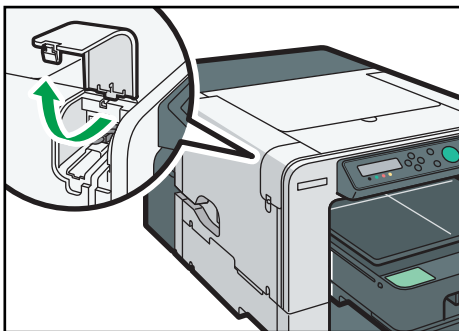

DYX017

**2. Plug the Ethernet cable into the port.**

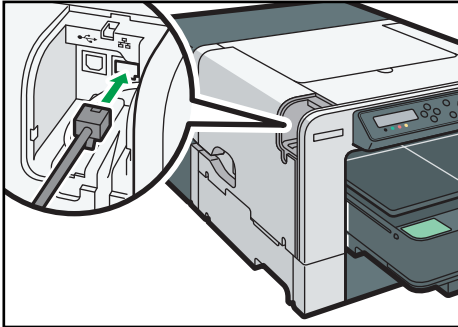

DYX020

**3. Connect the other end of the cable to the machine's network, such as to a hub.**

Check the LEDs on the Ethernet port.

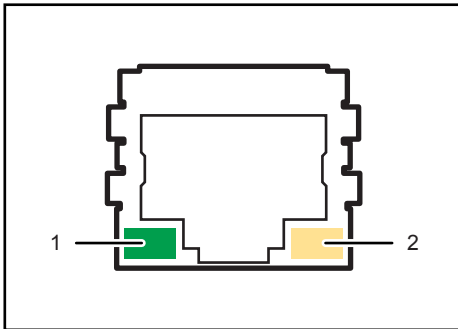

CHU123

**1. Indicator (green)**

Lights whenever the machine is properly connected to the network.

**2. Indicator (yellow)**

Lights whenever the machine is sending or receiving data via the network.

**4. Close the port cover.**

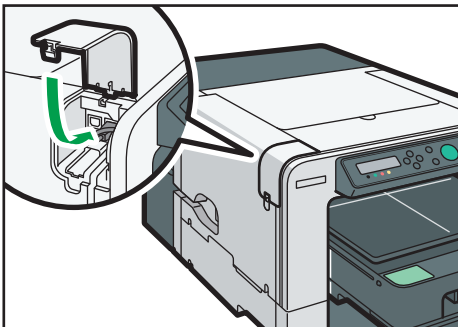

DYX048

## Network Settings for Ethernet and Wireless LAN

Make the following network settings according to the network interface you are using.

The following example explains how to allocate an IPv4 address.

1. Press the [Power] key.

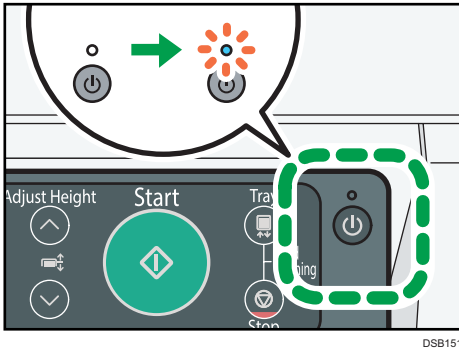

2. Press the [▼/Menu] key.

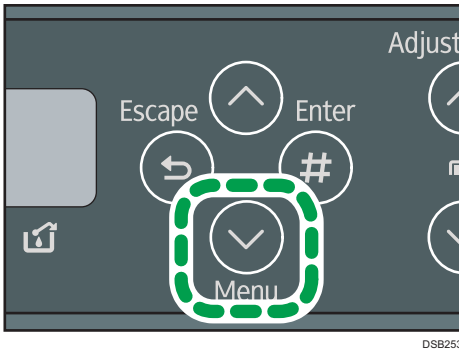

3. Press the [▲] or [▼/Menu] key to display the [Host Interface] menu, and then press the [#Enter] key.

```
<Menu>  
Host Interface
```

4. Press the [▲] or [▼/Menu] key to display [Network Setup], and then press the [#Enter] key.

```
<Host Interface>  
Network Setup
```

5. Press the [▲] or [▼/Menu] key to select [IPv4 Address], and then press [#Enter] key.

```
<Network Setup>  
IPv4 Address
```

The current IP address appears on the display.

6. Press the [▲] or [▼/Menu] key to enter the left most entry field of the IP address, and then press the [#Enter] key.

```
<IPv4 Address>
01█.022.033.044
```

To get an IP address for the machine, contact your network administrator.

The value moves by 10 if the [▲] or [▼/Menu] key is kept pressed.

7. Press the [#Enter] key.

The entered value is confirmed, and the cursor moves to the next field.

```
<IPv4 Address>
192.02█.033.044
```

To return to the previous field, press the [Escape] key.

8. Specify values in all fields, and then press the [#Enter] key.  
 9. Specify "IPv4 Subnet M." and "IPv4 Gateway.Ad." in the same way.  
 10. After you have made all the settings, press the [Escape] key.

The specified settings are set and the initial screen reappears.

You can print the configuration page to confirm the specified settings.

For details about how to print a configuration page, see page 111 "Printing a Configuration Page".

## Connecting the Machine via a Wireless LAN Interface

This section explains how to connect the machine to the network via a wireless LAN interface in the infrastructure mode.

In the infrastructure mode, communication is established via a wireless LAN access point.

### ★ Important

- Ad hoc mode is not supported.
- Ethernet and wireless LAN settings cannot be enabled at the same time.

## Checking your wireless network environment

Before using the wireless LAN, configure the following settings and make the check.

1. Before configuring the wireless LAN settings, configure the machine's IP address or make DHCP enabled.

For details about configuring the machine's IP address, see page 52 "Network Settings for Ethernet and Wireless LAN".

2. Check that the access point is operating.

2



CHV600

3. Plug the wireless LAN cable into the Ethernet port before configuring the wireless LAN settings.

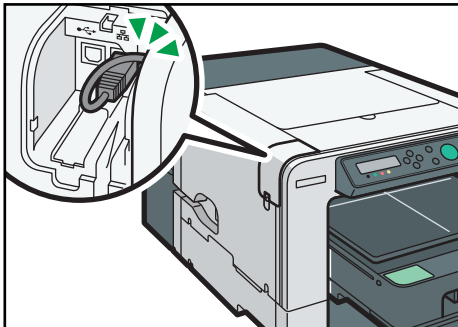

DYX023

## Selecting the configuration method

---

The configuration method depends on the access point being used.

"Easy Setup" is a function for automatically configuring the wireless LAN settings. The actual name of the function may vary depending on the access point being used. See the access point manual.

### ★ Important

- To use "Easy Setup", the access point must be set up with no security method, or be set up with one of the following security method.
  - WPS-PSK(AES)
  - WPA2-PSK(AES)



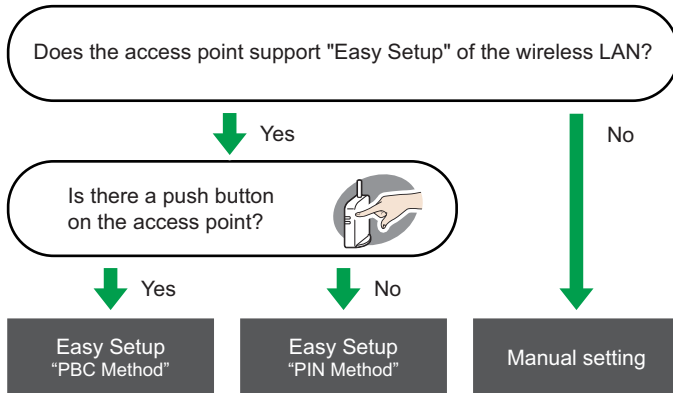

DSB252

2

## Easy Setup using the Push Button

1. Turn the machine on.

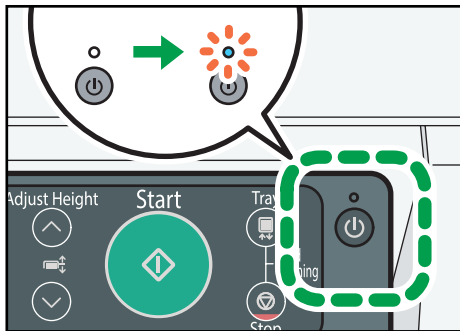

DSB151

2. Press the [▼/Menu] key.
3. Press the [▲] or [▼/Menu] key to display the [Host Interface] menu, and then press the [#Enter] key.

```
<Menu>
Host Interface
```

4. Press the [▲] or [▼/Menu] key to display [Wireless LAN], and then press the [#Enter] key.

```
<Host Interface>
Wireless LAN
```

5. Press the [▲] or [▼/Menu] key to select [Easy Setup], and then press the [#Enter] key.

```
<Wireless LAN>
Easy Setup
```

**6. Press the WPS button on the access point.**

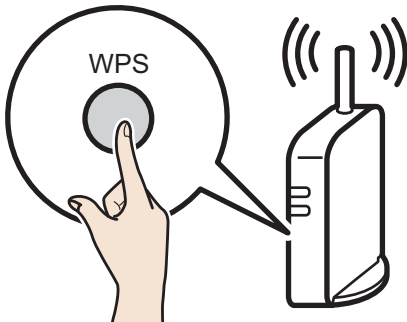

CHV607

**7. Press the [▲] or [▼/Menu] key to select [PBC Method], and then press the [#Enter] key.**



If the access point cannot be detected within 120 seconds, the search session expires.

If the connection attempt has failed, press the [#Enter] key again. If the problem persists, check whether the access point is working properly.

Configuration is complete when connection to the access point is confirmed.

**8. After you have made all the settings, press the [Escape] key.**

**9. Print the configuration page to check whether the machine has successfully connected to the access point.**

Check that the print media is set on the tray.

Press the [▼/Menu] key to display [List/Test Print], select [Config. Page], and then press the [#Enter] key to print the configuration page. When the "WL.LAN Signal" indicating the Wireless LAN signal in the configuration page is described as "(0%) Unavailable", the machine is not connected to the access point.

## Easy Setup using a PIN code

1. Turn the machine on.

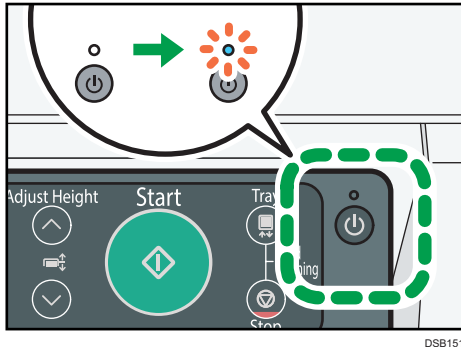

2. Press the [▼/Menu] key.
3. Press the [▲] or [▼/Menu] key to display the [Host Interface] menu, and then press the [#Enter] key.

```
<Menu>
Host Interface
```

4. Press the [▲] or [▼/Menu] key to display [Wireless LAN], and then press the [#Enter] key.

```
<Host Interface>
Wireless LAN
```

5. Press the [▲] or [▼/Menu] key to select [Easy Setup], and then press the [#Enter] key.

```
<Wireless LAN>
Easy Setup
```

6. Press the [▲] or [▼/Menu] key to select [Display PIN], and then press the [#Enter] key.

```
<Easy Setup>
Display PIN
```

7. Check the machine's PIN.

**8. Enter the machine's PIN on the access point web page.**

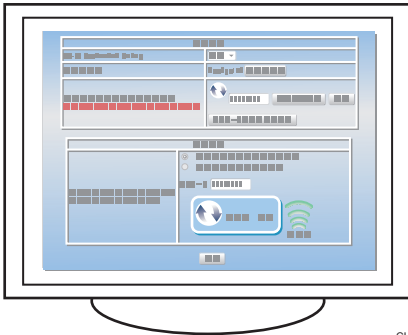

For details, see the manual supplied with the wireless LAN access point.

- 9. Execute WPS (PIN system) from the access point's web page.**
- 10. Press the [Escape] key.**
- 11. Press the [^] or [v]/Menu] key to select [PIN Method], and then press the [#Enter] key.**

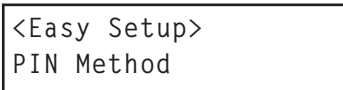

If the connection attempt has failed, press the [#Enter] key again. If the problem persists, check whether the access point is working properly.

Configuration is complete when connection to the access point is confirmed.

- 12. After you have made all the settings, press the [Escape] key.**
- 13. Print the configuration page to check whether the machine has successfully connected to the access point.**

Check that the print media is set on the tray.

Press the [v]/Menu] key to display [List/Test Print], select [Config. Page], and then press the [#Enter] key to print the configuration page. When the "WL.LAN Signal" indicating the Wireless LAN signal in the configuration page is described as "(0%) Unavailable", the machine is not connected to the access point.

## Manual setting

---

If you cannot confirm the settings of the access point being used or the access point does not support WPS, configure the wireless LAN settings manually.

You can configure the settings using Web Image Monitor or the control panel. This manual mainly explains configuration using Web Image Monitor.

### Configuring Settings Using Web Image Monitor

### ★ Important

- Connect the machine and computer with an Ethernet cable before configuring the settings.

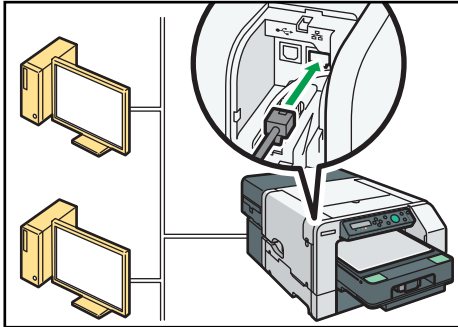

DYX024

- Check the security method employed by the access point being used.
- Check the machine's IP address. Press the [▼/Menu] key to display [Host Interface], select [Network Setup], and then select [IPv4 Address] to display the IP Address.

1. Launch the Web browser.
2. In the address bar, enter "http://(machine's IP address or host name)/".
3. Click [Administrator Login].



DSB201

A dialog box for entering the user name and password appears.

4. Enter the user name and password, and then click [OK].  
If this is the first time to log in, enter "admin" as the user name and leave the password blank.
5. In the menu area, click [Settings].
6. Click [Wireless LAN Settings].

### 7. Specify the wireless LAN settings.

#### If the security method is WEP

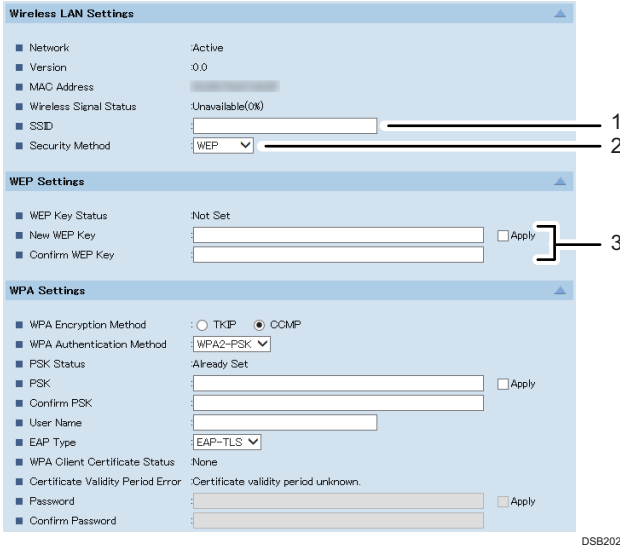

1. Enter the network name of the access point.
2. Select [WEP].
3. Enter the password for the access point, and then select the [Apply] check box.

#### If the security method is WPA

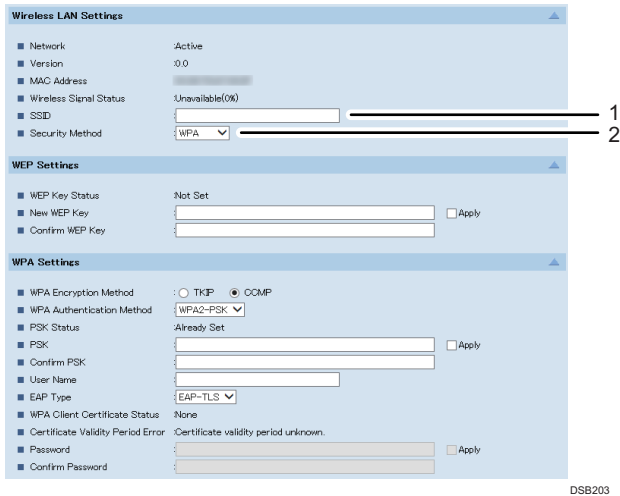

1. Enter the network name of the access point.
2. Select [WPA].

### If the WPA authentication method is WPA-PSK or WPA2-PSK

The screenshot shows the 'Wireless LAN Settings' window. The 'Security Method' is set to 'WPA'. Under 'WPA Settings', 'WPA Authentication Method' is set to 'WPA2-PSK' (indicated by arrow 1). The 'PSK' field is filled with a key and the 'Apply' checkbox is checked (indicated by arrow 2). Other settings like 'WPA Encryption Method' (TKIP/CCMP), 'EAP Type' (EAP-TLS), and 'Certificate Validity Period Error' are also visible.

1. Select [WPA-PSK] or [WPA2-PSK].
2. Enter the PSK (Pre-Shared Key), and then select the Apply check box.
3. Configure other settings if needed.

### If the WPA authentication method is WPA or WPA2

The screenshot shows the 'Wireless LAN Settings' window. The 'Security Method' is set to 'Inactive'. Under 'WPA Settings', 'WPA Authentication Method' is set to 'WPA' (indicated by arrow 1). The 'User Name' field is filled (indicated by arrow 2) and the 'EAP Type' is set to 'EAP-TLS' (indicated by arrow 3). The 'Password' field is filled and the 'Apply' checkbox is checked (indicated by arrow 4).

1. Select [WPA] or [WPA2].
2. Enter the user name for Extensible Authentication Protocol (EAP).
3. Select the EAP authentication type.
4. Enter the password for Protected Extensible Authentication Protocol (PEAP), and then select the [Apply] check box.

You can configure this setting if [EAP Type] is set to [PEAP].

Configure other settings if needed.

8. Click [OK].
9. Click [Administrator Logout].
10. Turn the machine off.
11. Remove the Ethernet cable, and then connect the wireless LAN cable.
12. Turn the machine on.

Setting is complete.

### Configuring Settings Using the Control Panel

#### ★ Important

- For details, see notes for Wireless LAN users on the access point manufacturer's Web site or page 140 "Using the [Host Interface] Menu".
1. Press the [▼/Menu] key.
  2. Press the [▲] or [▼/Menu] key to display the [Host Interface] menu, and then press the [#Enter] key.
  3. Press the [▲] or [▼/Menu] key to display [Wireless LAN], and then press the [#Enter] key.
  4. Press the [▲] or [▼/Menu] key to display [Security Method], and then press the [#Enter] key.
  5. Configure the wireless LAN settings.
  6. Press the [#Enter] key for 2 seconds or more to complete the input.

---

## Installing the Printer Driver

---

Once the machine is connected to the computer, install the printer driver.

There are two installation methods. Install the printer driver using one of these methods.

- Quick Install for Network  
Install the printer driver automatically. See page 62 "Quick Install for network".
- Manual install  
Configure the settings of the printer driver manually and install it. See page 64 "Installing the Printer Driver Manually Using the Network".

### Quick Install for network

---

Follow the procedure below to install the printer driver.

#### ★ Important

- Only administrators can perform this installation. Log on as a member of the Administrators group.



## Notes on the Installation

Although the Windows security warning may appear during installation, ignore it and continue with the installation.

**1. Insert the driver CD in the CD-ROM drive.**

Quit all other applications currently running.

**2. Select a language for the interface, and then click [OK].**

**3. Click [Quick Install for Network].**

**4. Read the entire license agreement carefully. If you accept its terms, click [I accept the agreement.], and then click [Next >].**

**5. Check that the power of the machine turns on, the Ethernet cable is connected, and the IP Address is set, and then click [Next].**

The search for the network printer starts.

**6. Click [Next >].**

**7. Click [Continue].**

Installation starts.

**8. If you want to make initial settings for the printer, click [Set Now].**

**9. Make initial settings, and then click [OK].**

**10. Select whether or not to open the Status Monitor automatically, and then click [Next >].**

**11. Click [Finish].**

When the dialog box asking whether you want to restart now appears, select [Yes, restart now.], and then click [Finish].

The printer driver is now installed.

### Note

- The installer launch automatically as Auto Run programs when you insert the CD-ROM. Auto Run might not work automatically with certain OS settings. If this is the case, double-click "SETUP.EXE", located on the CD-ROM root directory, or click [Run SETUP.EXE] in the [AutoPlay] dialog box.
- If a message prompting you to restart the computer appears, restart the computer.
- Confirm the printer driver is correctly installed by checking the Power lamp is lit, and then performing a test print. To perform a test print, open the [Printer Properties] dialog box, click [Print Test Page] on the [General] tab. If the test page does not print properly, see page 140 "Using the [Host Interface] Menu".

## Installing the Printer Driver Manually Using the Network

For a network connection, you can either perform direct printing (over a peer-to-peer network) using the Windows printer port or access the printer as a network printer via the print server.

### Using this Printer as the Windows Printing Port

2

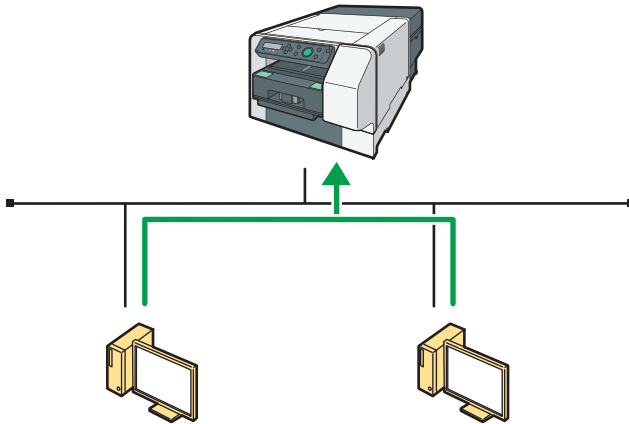

DYX053

### Using as a Network Printer

This printer can be used as the Windows network printer.

See page 68 "Using as the Windows network printer".

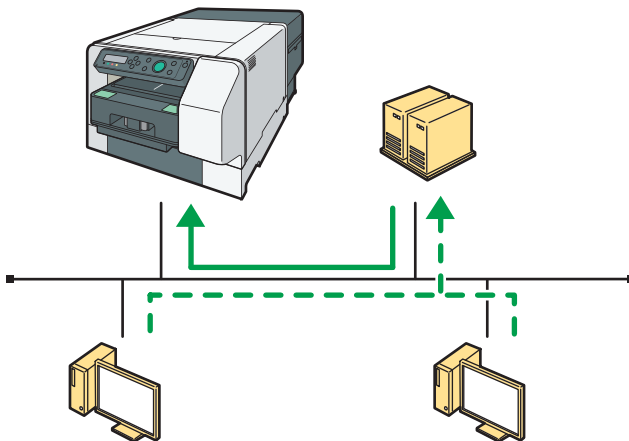

DYX054

### Using the standard TCP/IP port

This section explains how to install the printer driver (TCP/IP) and set up the Standard TCP/IP Port.

**★ Important**

- **Only administrators can perform this installation. Log on as a member of the Administrators group.**

**1. Insert the driver CD in the CD-ROM drive.**

Quit all applications currently running.

**2. Select an interface language, and then click [OK].****3. Click [Printer Driver].****4. Read the entire license agreement carefully. If you accept its terms, click [I accept the agreement.], and then click [Next >].****5. Click [Connect to a printer port or LAN], and then click [Next >].**

To search for printers automatically, select [Search for printers automatically], and then follow the wizard's instructions.

To search for a printer by its IP address, select [Search for printers by specified IP Address], and then follow the wizard's instructions.

If you do not search for a printer, select [Select a port or specify a new port]. In this example procedure, [Select a port or specify a new port] is selected.

**6. Select [Specify a new port] and click [Next >].****7. Click [Standard TCP/IP], and then click [Next >].****8. Click [Next >].****9. Enter the printer name or machine's IP address in the [Printer Name or IP Address] box, and then click [Next >].****10. Click [Finish].****11. If necessary, configure the default printer.****12. If necessary, configure the setting for sharing the printer.****13. Click [Continue].**

The printer driver installation starts.

**14. If you want to make initial settings for the printer, click [Set Now].****15. Make initial settings, and then click [OK].****16. Select whether or not to open the Status Monitor automatically, and then click [Next >].****17. Click [Finish].**

If a dialog box asking whether you want to restart now appears, select [Yes, restart now.], and then click [Finish].

**↓ Note**

- Although the Windows security warning may appear during installation, ignore it and continue with the installation.

- A message appears if there is a newer version of the printer driver already installed. If this is the case, you cannot install the printer driver using Auto Run. See page 222 "If a Message Appears during Installation".

## Using the LPR port

---

This section explains how to install the printer driver (TCP/IP) and set up the LPR Port.

### ★ Important

- **Only administrators can perform this installation. Log on as a member of the Administrators group.**

**1. Insert the driver CD in the CD-ROM drive.**

Quit all applications currently running.

**2. Select an interface language, and then click [OK].**

**3. Click [Printer Driver].**

**4. Read the entire license agreement carefully. If you accept its terms, click [I accept the agreement.], and then click [Next >].**

**5. Click [Connect to a printer port or LAN], and then click [Next >].**

To search for printers automatically, select [Search for printers automatically], and then follow the wizard's instructions.

To search for a printer by its IP address, select [Search for printers by specified IP Address], and then follow the wizard's instructions.

If you do not search for a printer, select [Select a port or specify a new port]. In this example procedure, [Select a port or specify a new port] is selected.

**6. Select [Specify a new port] and click [Next >].**

**7. Click [LPR Port], and then click [Next >].**

If [LPR Port] does not appear, see Windows Help and install it.

**8. Enter the machine's IP address in the [Name or address of server providing lpd] box.**

**9. Enter "lp" in the [Name of printer or print queue on that server] box, and then click [OK].**

**10. If necessary, configure the default printer.**

**11. If necessary, configure the setting for sharing the printer.**

**12. Click [Continue].**

The printer driver installation starts.

**13. If you want to make initial settings for the printer, click [Set Now].**

**14. Make initial settings, and then click [OK].**

**15. Select whether or not to open the Status Monitor automatically, and then click [Next >].**

**16. Click [Finish].**

If a dialog box asking whether you want to restart now appears, select [Yes, restart now.], and then click [Finish].

**Note**

- Although the Windows security warning may appear during installation, ignore it and continue with the installation.
- A message appears if there is a newer version of the printer driver already installed. If this is the case, you cannot install the printer driver using Auto Run. See page 222 "If a Message Appears during Installation".

**Using the IPP port****1. On the [Start] menu, click [Devices and Printers].**

- For Windows 10: Right-click the [Start] button, and then click [Control Panel]. Once the [Control Panel] window is displayed, click [View devices and printers].

**2. Click [Add a printer].**

- For Windows 10: Go to step 4.

**3. Click [Add a network, wireless or Bluetooth printer].****4. Click [The printer that I want isn't listed].****5. In the [Select a shared printer by name] box, enter "http://(machine's IP address)/printer (or ipp)" as the printer's address, and then click [Next].****6. Click [Have Disk...].****7. Insert the CD-ROM in the CD-ROM drive.**

If the [AutoPlay] dialog box appears, click [Close].

**8. Click [Browse...], and then specify a location for the INF file.**

The Drivers are in the following folders on the supplied CD-ROM.

- RPCS raster printer driver for the 32-bit Windows  
DRIVERS\X86\RPCS\_R\X86\disk1
- RPCS raster printer driver for the 64-bit Windows  
DRIVERS\X64\RPCS\_R\X64\disk1

**9. Click [Open], and then click [OK].****10. Follow the wizard's instructions to install the printer driver.**

## Using as the Windows network printer

This section assumes that the client has already been configured to communicate with a print server. Do not begin the following procedure before the client is set up and configured correctly.

To use the print server, install the printer driver by selecting "Network printer server", and then select the shared printer.

### ★ Important

- Only administrators and power users can perform this installation. Log on as a member of the Administrators or Power Users group.
- If you print with a Windows Vista/7/8.1/10 or Windows Server 2008/2008 R2/2012/2012 R2/2016, notification functions may not be used with the client.

#### 1. Insert the driver CD in the CD-ROM drive.

Quit all applications currently running.

#### 2. Select an interface language, and then click [OK].

#### 3. Click [Printer Driver].

#### 4. Read the entire license agreement carefully. If you accept its terms, click [I accept the agreement.], and then click [Next >].

#### 5. Click [Connect to a printer port or LAN], and then click [Next >].

To search for printers automatically, select [Search for printers automatically], and then follow the wizard's instructions.

To search for a printer by its IP address, select [Search for printers by specified IP Address], and then follow the wizard's instructions.

If you do not search for a printer, select [Select a port or specify a new port]. In this example procedure, [Select a port or specify a new port] is selected.

#### 6. Select [Specify a new port] and click [Next >].

#### 7. Click [Network Printer], and then click [Next >].

#### 8. Double-click the computer name you want to use as a print server in the [Browse for Printer] window.

#### 9. Select the printer you want to use, and then click [OK].

#### 10. If necessary, configure the default printer.

#### 11. If necessary, configure the setting for sharing the printer.

#### 12. Click [Continue].

The printer driver installation starts.

#### 13. If you want to make initial settings for the printer, click [Set Now].

#### 14. Make initial settings, and then click [OK].

#### 15. Select whether or not to open the Status Monitor automatically, and then click [Next >].

## 16. Click [Finish].

If a dialog box asking whether you want to restart now appears, select [Yes, restart now.], and then click [Finish].

### Note

- The installer launch automatically as Auto Run programs when you insert the CD-ROM. Auto Run might not work automatically with certain OS settings. If this is the case, double-click "SETUP.EXE", located on the CD-ROM root directory, or click [Run SETUP.EXE] in the [AutoPlay] dialog box.
- Although the Windows security warning may appear during installation, ignore it and continue with the installation.
- A message appears if there is a newer version of the printer driver already installed. If this is the case, you cannot install the printer driver using Auto Run. See page 222 "If a Message Appears during Installation".
- If the Windows network printer settings are not configured correctly, installation will fail. In this case, cancel the installation and correctly configure the Windows Networks settings. For details about configuring the settings, see page 48 "Setting up a server".

# Fabric

This section explains the usable fabric and precautions regarding fabric.

---

## Usable Fabric

---

2

This machine can print on fabric having a 50 to 100% cotton blending ratio.

The print quality of T-shirts with pockets, polo sleeves (sleeve and back side), T-shirts for pets, towels, handkerchiefs, bibs, etc. is not guaranteed. Use the machine at your own risk.

### ★ Important

- As the A4 standard tray and A5 tray becomes hot when continuously used on the optional finisher, give an interval of five minutes or longer to set them after they are pulled out.

---

## Precautions Regarding Fabric

---

### ⚠ CAUTION

- When loading or removing fabric, keep your hands or fingers clear of the tray. Otherwise, your hands or fingers might get caught, resulting in injury.

---

## Loading fabric precautions

---

- Remove dust or lint from the print side of the fabric with a lint brush or a roller beforehand.
- Press down the fabric on the table as much as possible so that the fabric does not come off. Also, set the fabric parallel to the table.

---

## Fabric type precautions

---

### Thin fabrics

- With thin fabrics, ink bleeding through them may adhere to other parts. You can avoid this happening by placing paper on the back side.

---

## Non-compatible fabric

---

- Fabrics having a cotton blend ratio of 50% or less (the machine cannot print on quick-drying and dry fabrics)



## Printable area

Printable and unprintable areas

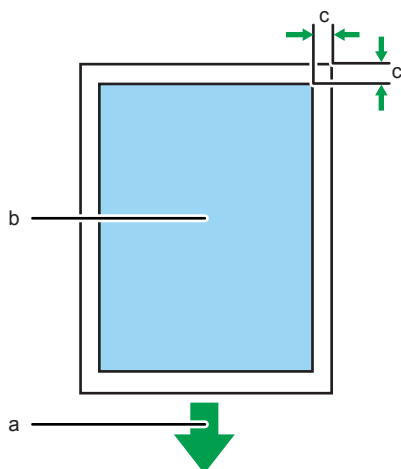

CHU027

- a. Front of the Tray
- b. Printable Area
- c. Windows: 3 mm (0.12 inches), Mac: 3 mm (0.12 inches)

The printing ranges of each tray are as follows:

- A4 standard tray: 291 × 204 mm (11.5 × 8.0 inches)
- A5 tray: 204 × 142 mm (8.0 × 5.6 inches)
- Sleeve & Socks Tray: 204 × 142mm (8.0 × 5.6 inches)

# Loading Fabrics

This section explains the procedures for loading fabrics.

## ⚠ CAUTION

- When loading or removing fabrics, keep your hands or fingers clear of the tray. Otherwise, your hands or fingers might get caught, resulting in injury.

## Loading a Fabric in the Standard Tray

This section explains how to load a fabric in the A4 standard tray. The same operation applies when the A5 tray is used.

### ★ Important

- When printing on thin fabrics, the ink may adhere to the table. Place paper or something similar on the table before loading the fabric.

#### 1. Press the [Power] key.

Remove the tray after turning the power on. If the tray is mistakenly removed before turning the power on, turn the power off once, and then turn the power on again.

#### 2. Check that the tray stand comes to the front.

If the tray stand does not come to the front, press the [Tray] key and move the tray to the front.

#### 3. Lift the tray slightly, pull it to the front to remove it.

#### 4. Press the unlock button and lift the cover.

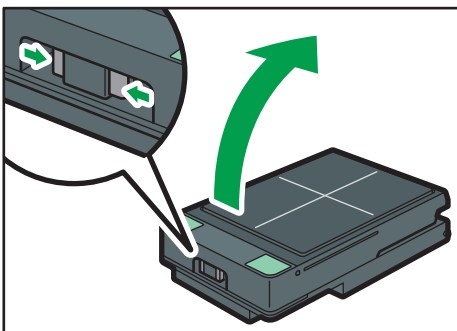

DSA348

#### 5. Put marks on the fabric for when loading it in the tray.

The image will be printed in the direction from the front side to the back side of the tray. Turn the protection cover inside out and put it on the fabric in the direction as shown in the figure, and then use a pen with erasable ink to make the marks through the holes in the protective cover.

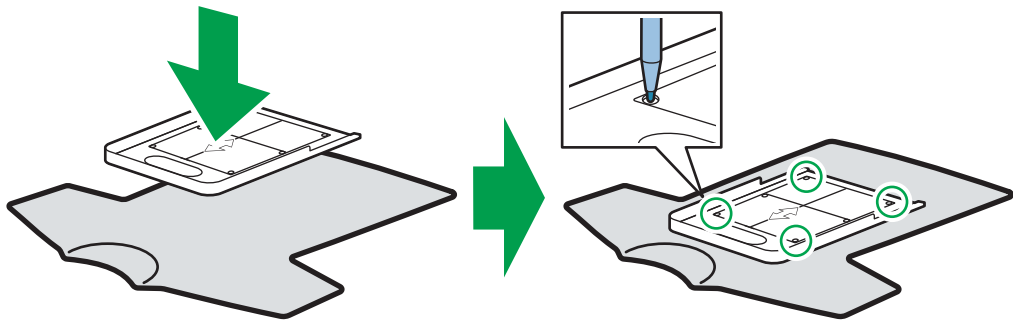

DSA071

## 6. Load the fabric on the table.

When loading the fabric, align the corners of the table with the marks on the fabric.

- When loading a T-shirt or sweatshirt

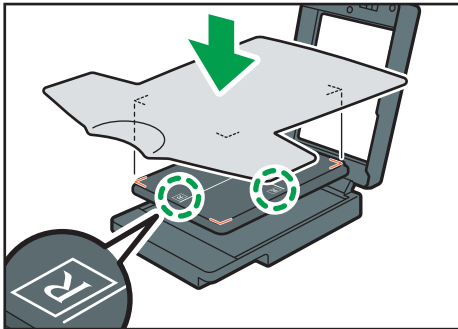

DSA219

- When loading a canvas tote bag or natural cotton tote bag

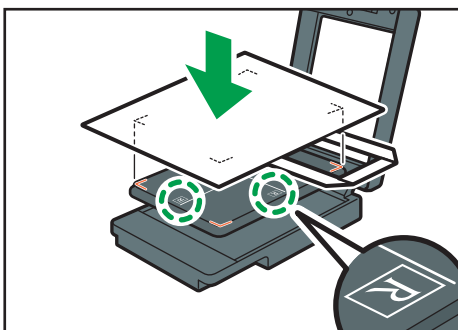

DSA220

When loading a medium size canvas tote bag or natural cotton tote bag in the A4 standard tray, the tray might not have enough space for the tote bag. If it is difficult to load the tote bag in the A4 standard tray, use the A5 tray for the tote bag.

When you print on a natural cotton tote bag or a T-shirt other than a Heavyweight T-shirt, the ink may bleed through the fabric and stain other parts. You can prevent this staining by inserting a piece of paper against the inner side.

**7. Tuck the edges of the fabric under the table.**

Smooth out the fabric so that no wrinkles or slack remain on the print surface.

Tuck the fabric so that no wrinkles or folds remain in the area at the edges of the table.

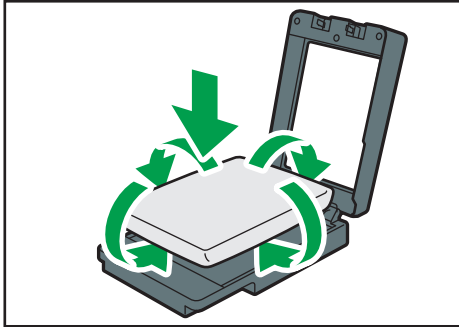

DSA370

**8. After checking that no wrinkles or slack remains on the print side, close the cover. As you close the cover, smooth away wrinkles with your hand.**

Check that the fabric is not protruding from the tray.

When using the optional finisher, smooth wrinkles and flatten fibers after loading the fabric in the tray.

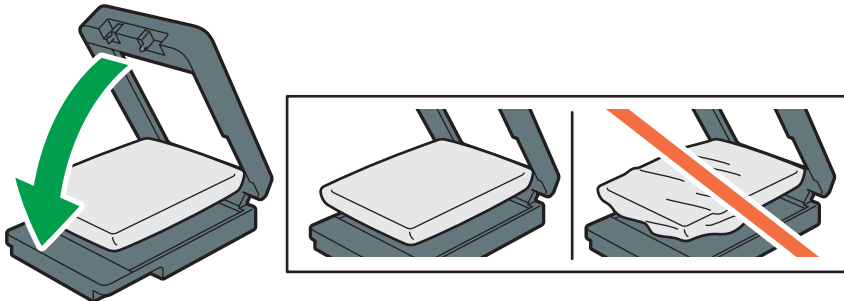

DSA014

After closing the cover, make sure that the fabric is loaded so its surface is parallel to the cover.

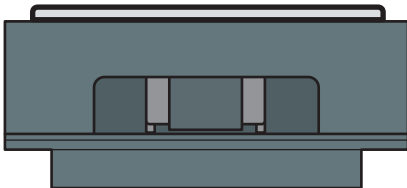

DSA217

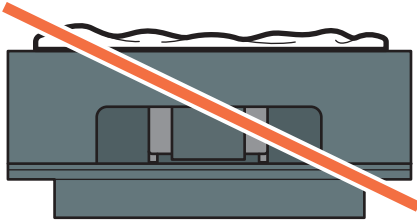

DSA218

9. After closing the cover, if there are still wrinkles or slack on the printing surface at the center of the table, push both ends of the tray lightly and push the fabric under the table.

After closing the cover, check that the fabric is not caught between the cover and the tray.

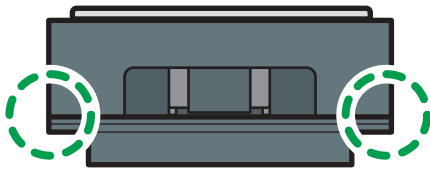

DSA048

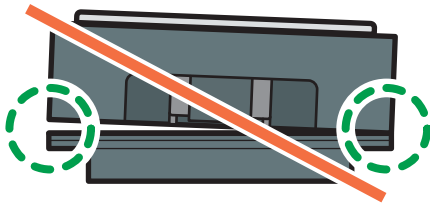

DSA049

## Loading Socks in the Sleeve & Socks Tray

When you want to print on socks, use the Sleeve & Socks Tray.

### ★ Important

- To use Sleeve & Socks Tray, you need to install the latest firmware (ver. 1.20 or later) on the machine.
- If you perform printing with the edges of the fabric still outside of the table, the fabric or this machine might be damaged. After fixing the fabric, make sure that it fits within the width of the tray.
- Do not forcibly lift or twist the table. Doing so may cause a failure.

1. Press the [Power] key, and then turn on the machine.

Detach the tray after turning on the machine. If you detach the tray before turning on the machine, turn it off first, and then turn it on again.

2. Make sure that the tray stand is out of the machine, and then detach the tray.

- If it is not out of the machine, press the [Tray] key to eject the tray.

- Lift up the tray lightly and pull the tray to detach it.

**3. Press the unlock button to open the cover.**

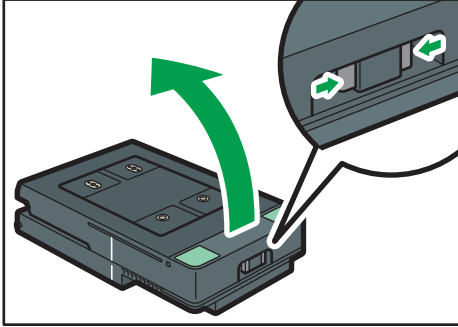

DYX063

**4. Load the socks on the table.**

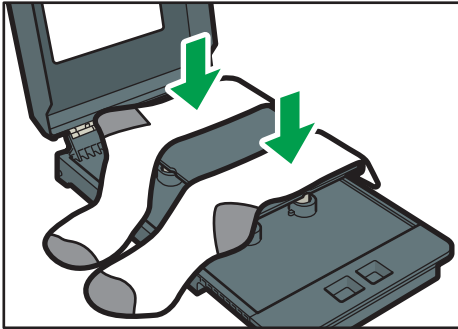

DYX064

**5. Tuck the edges of the fabric under the table.**

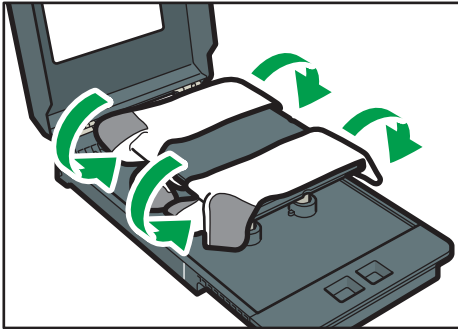

DYX065

6. Make sure that no wrinkles or slack remain on the print surface, and then close the cover.

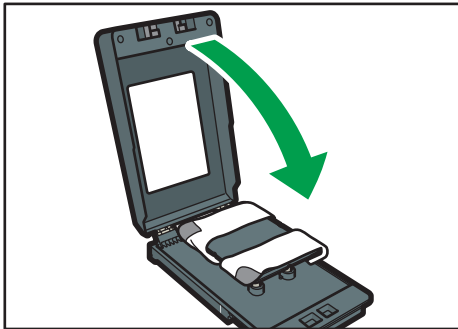

DYX066

7. Load the tray in the tray stand and start printing.

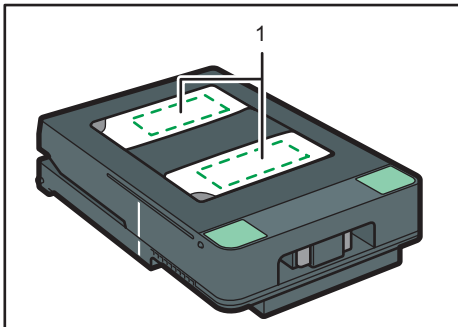

DYX072

### 1. Printable area

#### ↓ Note

- Load the fabric so that its surface is as flat as possible and it is parallel to the table.

#### Printable area of socks

You can print socks in the positions shown.

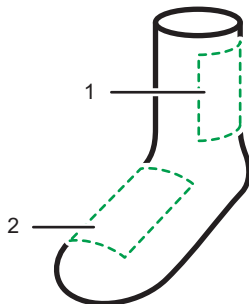

DYX074

1. Leg
2. Instep

- Example: Instep

When printing on the instep, widen and load the fabric so that the printable area of the instep is in the middle.

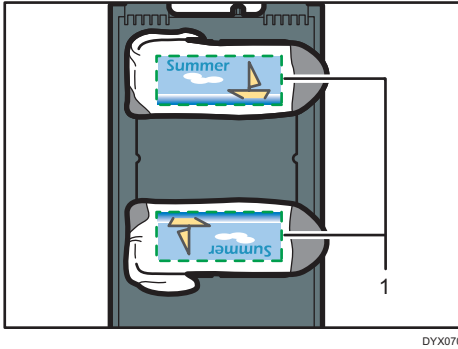

1. Printable area

## Loading a Sleeve in the Sleeve & Socks Tray

When you want to print on the sleeves of a garment, use the Sleeve & Socks Tray.

### ★ Important

- To use Sleeve & Socks Tray, you need to install the latest firmware (ver. 1.20 or later) on the machine.
- If you perform printing with the edges of the fabric still outside of the table, the fabric or this machine might be damaged. After fixing the fabric, make sure that it fits within the width of the tray.
- Do not forcibly lift or twist the table. Doing so may cause a failure.

#### 1. Press the [Power] key, and then turn on the machine.

Detach the tray after turning on the machine. If you detach the tray before turning on the machine, turn it off first, and then turn it on again.

#### 2. Make sure that the tray stand is out of the machine, and then detach the tray.

- If it is not out of the machine, press the [Tray] key to eject the tray.
- Lift up the tray lightly and pull the tray to detach it.

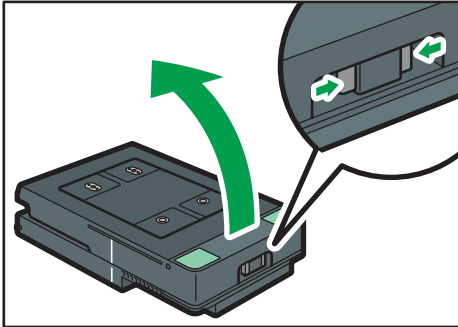

**3. Press the unlock button to open the cover.**

DYX063

**4. Slip the sleeve onto the table.**

If you cannot slip it on, load it onto the table.

Align the perforation with the indentation on the table.

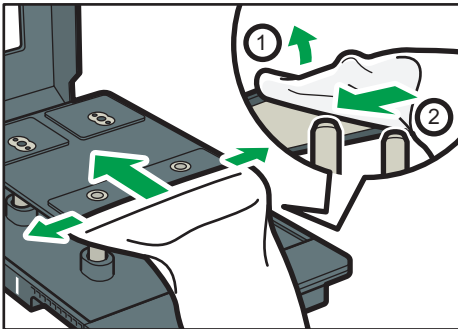

DYX067

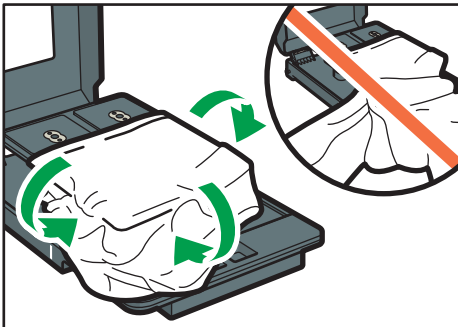
**5. Tuck the edges of the fabric under the table.**

DYX068

6. Make sure that no wrinkles or slack remain on the print surface, and then close the cover.

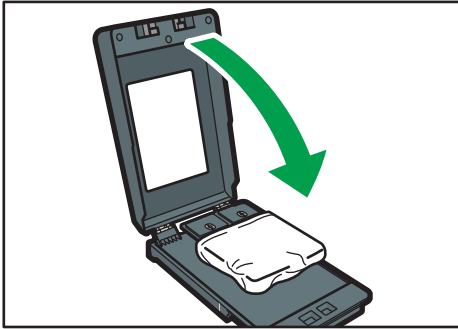

DYX069

7. Load the tray in the tray stand and start printing.

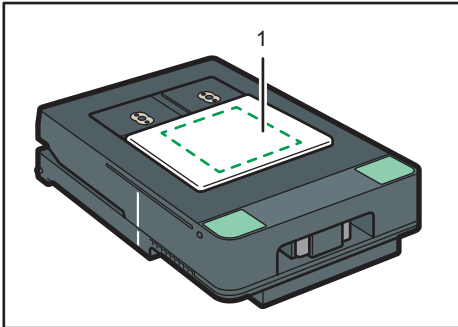

DYX073

**1. Printable area**

**Printable area of socks**

You can print socks in the positions shown.

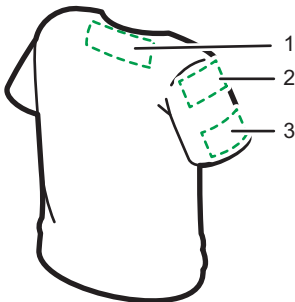

DYX075

**1. Collar**

**2. Shoulder**

**3. Sleeve**

**Note**

- You can print without margins on the sleeves. Cover the table with paper so the table does not get dirty, and then position the sleeve of the garment.

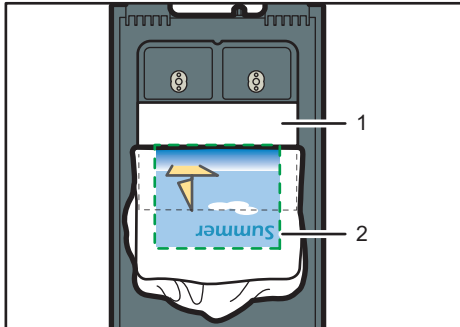

DYG071

1. Paper
2. Printable area



# 3. Printing on T-shirts

This section explains the procedures for printing on T-shirts. In order to create printing data and perform printing, use the "Design Software" application dedicated for T-shirt printing. For printing procedures using applications other than Design Software, see page 97 "Printing via the Printer Driver".

## About Design Software

Design Software is application software for printing on T-shirts using this machine. You can use this application by installing it on Windows or Mac.

### Operating Environment

Use the Design Software under the following conditions:

- Supported device: Devices running a Windows operating system or Microsoft .NET Framework 4.5 or later, devices running a Mac OS X® (iMac®, MacBook®, Mac mini®, etc.)
- Supported operating system: Windows 7/8.1/10 (32-bit/64-bit), Mac OS X 10.10.x or later
- Supported display resolutions: 1280 × 800 or higher

**Note**

- We cannot guarantee that Design Software operates properly if it is installed on an unsupported operating system even though it could be installed there.

### Installing

Connect the CD-ROM drive to the Windows or Mac and install the Design Software.

- 1. Insert the driver CD into the CD-ROM drive.**  
If another application software is running, exit it.
- 2. Click [RICOH Design Software].**
- 3. Follow the on-screen instructions to install the application.**

When the Windows security warning appears during installation, ignore it and continue the installation.

---

## Launching

---

### Windows:

Click [All Programs] from the [Start] menu in Windows, and then click [RICOH Design Software] - [RICOH Design Software].

Alternatively, double-click the [RICOH Design Software] shortcut created on the desktop.

### Mac:

Click [RICOH Design Software] from the [Launchpad].

Alternatively, double-click [RICOH Design Software] in the [Applications] folder of the [Finder].

---

## Exiting

---

### Windows:

When using a computer, click [x] in the top right corner of the application screen. When using a tablet, flick the tablet screen from the left edge to the center with your finger and tap [x] on the top right corner of [RICOH Design Software] when it is displayed.

### Mac:

Click [x] on the top left corner of the application screen.

# Creation Flow

The operation flow for printing on T-shirts is as follows. Steps 3 to 7 are the operations using the Design Software.

## ★ Important

- To use Sleeve & Socks Tray, you need to install the latest firmware (ver. 1.20 or later) on the machine.
- Use the latest version of the Design Software. See the latest help for the operating procedures.

## ⚠ CAUTION

- Do not use the optional finisher for purposes other than flattening fibers, removing wrinkles, and fixing ink. Doing so may cause a fire.

Step	Task	Reference for full details
1	This is the process to print on T-shirts clearly. The optional finisher is used.	page 87 "Removing Dust and Flattening Fibers"
2	Load a T-shirt into the tray in accordance with the size of the T-shirt.	page 88 "Loading a T-shirt in the Tray"
3	Launch the Design Software and configure the settings for the printing fabric you want to use.	See the Design Software Help.
4	Select the tray size to be used and the printing direction in the Design Software.	See the Design Software Help.
5	Select the image to print, and then fetch it in the Design Software. It is also possible to shoot an image in your tablet or smart phone using the camera on the spot.	See the Design Software Help.
6	Edit the image using the Design Software and lay it out.	See the Design Software Help.
7	Load the tray in the machine, and then print the image created by the Design Software using the machine.	page 89 "Printing"
8	Remove the printed T-shirt from the tray.	page 92 "Removing the T-shirt from the Tray"

Step	Task	Reference for full details
9	Use the optional finisher to fix the printed image onto the T-shirt.  For reference, in the case of a commercially available heat press, ink was fixed at 330°F (approx. 165°C) in 90 seconds.	page 94 "Fixing Ink"

3

According to this flow, each procedure is explained in detail below.



# Removing Dust and Flattening Fibers

This process is to print on T-shirts clearly. The optional finisher is used.

## ★ Important

- As the A4 standard tray, A5 tray, and Sleeve & Socks Tray becomes hot when continuously used on the optional finisher, give an interval of five minutes or longer to set them after they are pulled out.
- Do not print on wet fabric. Doing so may result in a blurry image.
- Do not use the spray. If you wet the T-shirt with the spray, the color of the tray may stain the back of the T-shirt.
- In high temperature environments, fabric might absorb moisture and stretch after smoothed. Print immediately after loading the fabric.
- Remove dust and lint from fabric before printing because dust and lint whose color is the same with the fabric color are hard to find, we recommend using a lint roller to remove dust and lint from fabric before smoothing it.

### 1. Remove dust and lint from the print surface of the T-shirt.

Remove them with a lint brush for clothes or a roller.

### 2. Use the finisher to flatten fibers and remove wrinkles from the T-shirt.

## ↓ Note

- When using the finisher, you can carry out heat press processing for the T-shirt loaded in the A4 standard tray, A5 tray, or Sleeve & Socks Tray.

## Loading a T-shirt in the Tray

Load a T-shirt in the tray. For details of the procedure, see page 72 "Loading a Fabric in the Standard Tray".

### Important

- The image will be printed in the direction from the front side to the back side of the tray.
- Load the fabric so that it does not protrude from the tray.

# Printing

Using the Design Software, perform printing.

## ★ Important

- Do not touch the tray or put your hand in the machine while printing is performed.
- Do not open the top cover while printing is performed. Printing is forcibly interrupted and cannot be resumed.
- When a garment misfeed error is indicated, see page 208 "Adjusting the Height of the Tray".
- Do not print if no fabric is loaded on the tray. It may cause the ink to stick to the tray. After printing without loading a fabric in the tray, do the following:

Solutions if Printing Was Performed Without a Fabric Loaded in the Tray

1. Wipe the tray with a dry cloth.

Do not use tissue paper because it makes the tray dirty.

Use polythene gloves to avoid touching the ink directly.

Do not use chemicals such as thinner or ethanol.

2. Dry the remaining ink using the optional finisher or an iron.

Stains might remain on the tray, which can still be used however.

When using the optional finisher, use it in dry mode.

When ironing, lay down a sheet of paper on the surface of the tray, and apply the iron to the paper.

After drying the ink, rub the surface of the tray, with a cloth to check whether or not the ink is dry. If ink does not stick to the cloth, the ink has dried completely.

1. **Load the tray in the tray stand.**

Place the rear side of the tray in the tray stand, and then push it in slowly all the way until you hear it click.

You can check if the tray is correctly positioned using the line on the left side of the tray.

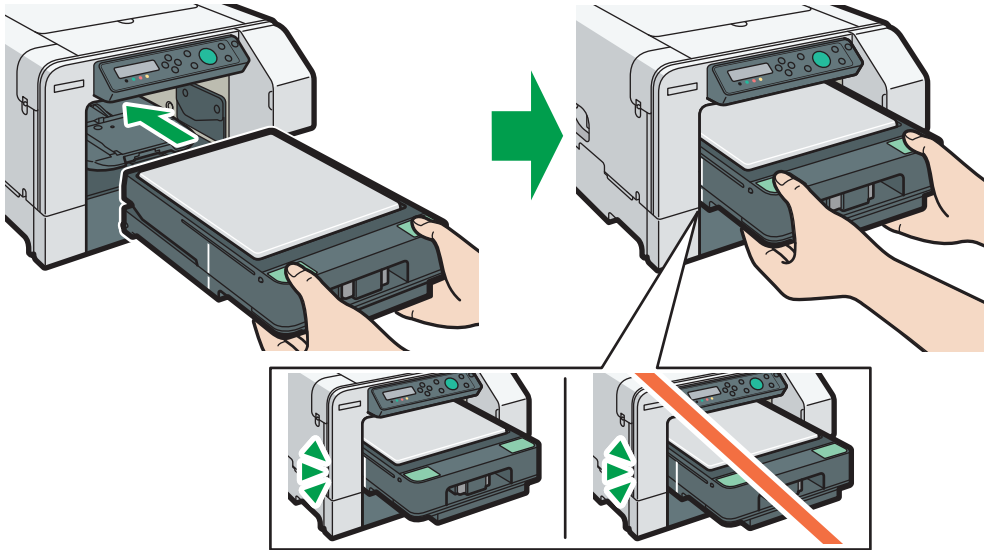

DSA063

**2. Click [Start Printing] on the Design Software.**

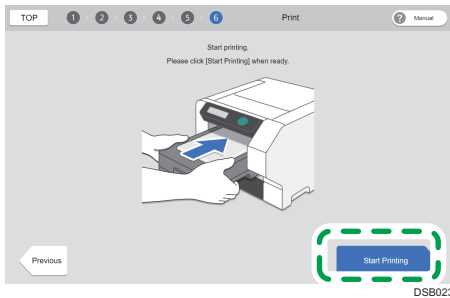

DSB023

Printing data is sent to the machine.

Once the machine receives the data correctly, the [Start] key on the machine lights up blue.

**3. Make sure that the [Start] key lights up blue, and then press the [Start] key.**

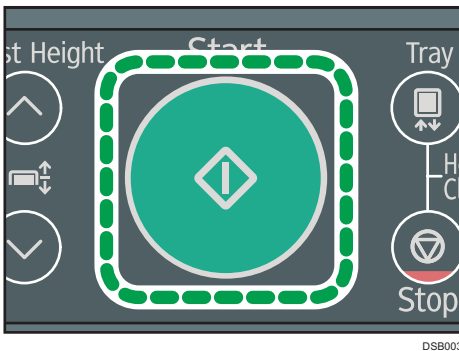

DSB003

After the tray is loaded into the machine and the height of the table is automatically adjusted, printing starts.

#### 4. Once the tray returns to the front side of the machine, remove the tray.

- While the [Start] key is lit, printing has not been finished. Press the [Start] key again without removing or moving the tray from the machine. Printing resumes.
- When using the A4 standard tray or A5 tray, insert the protection cover horizontally as illustrated in the figure, and then remove it with the A4 standard tray or A5 tray. This prevents you from coming into contact with the printing surface. Make sure the protection cover is correctly positioned horizontally.

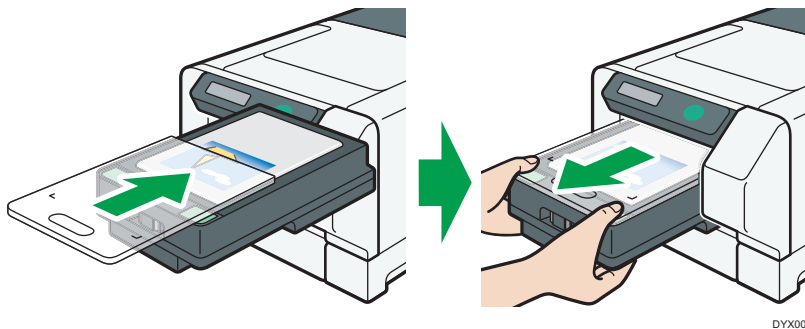

DYX008

3

#### 5. Finish the Design Software.

- By clicking [Print One More], you can configure the layout settings again for the image loaded.
- Clicking [Back to TOP] discards the loaded image and returns you to the top screen of the Design Software.

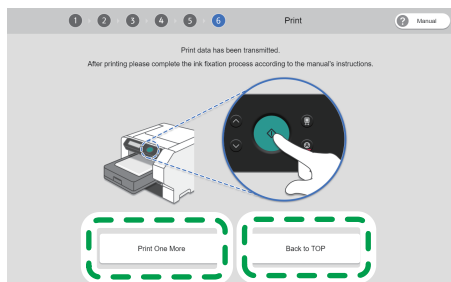

DSB024

## Removing the T-shirt from the Tray

**★ Important**

- When removing the T-shirt, be sure to prevent the print surface from touching any other part.
- If you touch the print surface before the ink fixes, the ink might blot on the fabric.

When using the A4 standard tray or A5 tray

1. Press the unlock button and lift the cover.

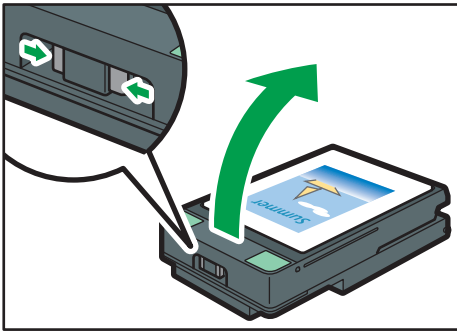

DSA357

2. Pull out the tucked edges of the fabric.

Be careful not to touch the printed side.

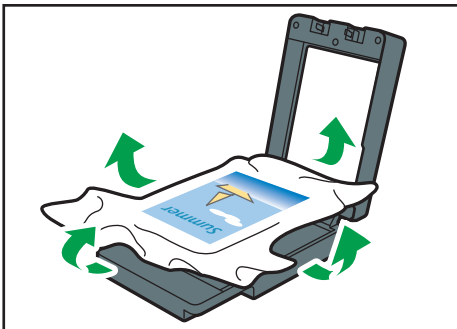

DSA342

3. Hold the T-shirt by the shoulders and remove it from the tray.

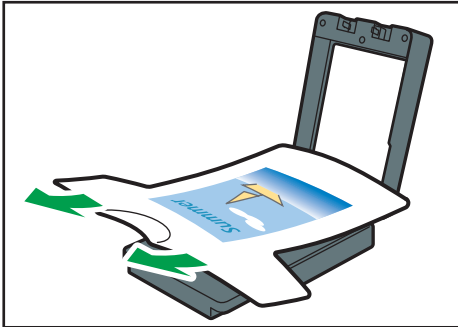

DSA344

## Fixing Ink

Use the optional finisher to fix the ink to the fabric.

### ★ Important

- As the A4 standard tray, A5 tray, and Sleeve & Socks Tray becomes hot when continuously used on the optional finisher, give an interval of five minutes or longer to set them after they are pulled out.

### ↓ Note

- For reference, in the case of a commercially available heat press, ink was fixed at 330°F (approx. 165°C) in 90 seconds.
- When using the finisher, you can carry out heat press processing for the T-shirt loaded in the A4 standard tray, A5 tray, or Sleeve & Socks Tray.



# Handling Printed Goods

## Precautions When Washing Printed Goods

Note the following handling precautions for T-shirts and sweatshirts:

- Turn garments inside out before washing them.
- When washing T-shirts and other garments by hand, dissolve some neutral detergent in lukewarm water of about 30°C (approx. 86°F) and wash them without rubbing the printed areas. After that, spin them dry for about 1 minute in a washing machine, smooth wrinkles, and then hang them to dry.



DSA541

- Do not rub the printed surfaces. Doing so may cause discoloration due to friction.



DSA542

- When washing T-shirts and other garments in a washing machine, turn them inside out so the printed side is inside and put them in a laundry net. After washing them, shake out as much water as possible, smooth out wrinkles, and hang them in the shade to dry.

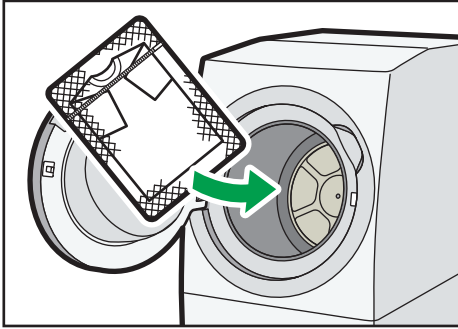

DSA543

3

- Do not use a dryer or bleach.
- Avoid ironing the printed surfaces.
- Do not dry-clean garments.

Note the following handling precautions for tote bags:

- Do not machine wash tote bags. Doing so may cause the tote bag to lose its shape or cause its colors to fade.
- When washing tote bags by hand, dissolve some neutral detergent in lukewarm water of about 30°F (approx. 86°F) and wash them without rubbing their printed areas. After washing a tote bag, shake it out to remove as much water as possible. Then, flatten it to remove wrinkles and dry it in the shade.

# 4. Printing via the Printer Driver

This chapter explains the printer driver setting screen and basic printing procedures using an application other than the Design Software.

This guide uses Windows 7/10 procedures for its examples. Procedures and screens might vary depending on the operating system you are using.

For printing procedures using the T-shirts Designer, see page 83 "Printing on T-shirts".

## Setting the Accessories Tab on the Printer Driver

### ★ Important

- Only administrators can set this. Log on as a member of the Administrators group.

**1. From the [Start] menu, click [Devices and Printers].**

- For Windows 10: Right-click the [Start] button, and then click [Control Panel]. Once the [Control Panel] window is displayed, click [View devices and printers].

**2. Right-click the machine icon, and then click [Printer properties].**

**3. Click the [Accessories] tab.**

**4. Click [Adjust Color Density...].**

**5. Adjust the color density within the range of 1 to 9.**

The bigger the number, the darker the color.

The number can be directly input in the entry field or changed by clicking the up and down pointing triangles.

**6. Click [OK].**

**7. Click [OK] to close the [Printer Properties] dialog box.**

# Printing

In this example, the procedure using Microsoft Paint is explained.

How to open the setting screen of the printer driver depends on the application.

For details, see the user manual for the application.

- You can select the print quality from the following:
  - Speed  
Print speed increases while the image quality does not deteriorate.
  - Fine  
Image quality is prioritized.
  - Vivid  
Intensity is prioritized. In this mode, as the machine prints one sheet, the counter value is incremented by 2.
- Ink consumption increases when you set [Select Print Quality:] to [Vivid] or [Garment Type:] to [Thick Garment] in the printer driver.
- When printing from Windows Photo Viewer, you cannot change the resolution from the "Quality:" pull-down menu of Windows Photo Viewer. To change the resolution from Windows Photo Viewer, click [Options...], and then select the print quality from [Printer Properties...].

## 1. Load on the tray stand the tray in which the fabric has been loaded.

How to load the fabric depends on the fabric type. See page 72 "Loading Fabrics".

## 2. Click [Print] from [Print] on the menu.

## 3. Select the machine from the [Select Printer], and then click [Preferences].

## 4. Click the [One Click Presets] tab.

## 5. In [Garment type:], select the fabric type.

In [Garment type:], select the fabric type.

For example, we recommend the following for cut and sewn (knits) and woven fabrics:

- 4.5 - 7.0 oz: [T-shirt (White/Pale)]
- 5.5 oz or more: [Thick Garment]
- 5.5 oz or less: [Thin Garment]

If multiple conditions apply at the same time, first confirm the settings in [T-shirt (White/Pale)], such as printing speed and image quality, and then, if necessary, select a different mode. If you determine that the settings, such as printing speed and image quality, are appropriate, then the existing mode can be used without problem.

If necessary, specify the other printing conditions.

## 6. Click [OK].

7. Click [Print].

8. Press the [Start] key on the machine.

**Note**

- For details about how to handle the tray, see page 22 "Loading and Removing the Tray".
- For usable fabric types and precautions, see page 70 "Fabric".
- Opening the setting screen of the printer driver in the application displays the descriptions configured as default values. On this screen, change the necessary settings only and print.
- The settings changed here are effective only in this application. When printing is performed using other applications, the settings here are not reflected. Depending on the application, the setting contents of the printer driver may be automatically changed.

## Displaying the Printing Settings

1. From the [Start] menu, click [Devices and Printers].

- For Windows 10: Right-click the [Start] button, and then click [Control Panel]. Once the [Control Panel] window is displayed, click [View devices and printers].

2. Right-click the machine icon, and then click [Printing Preferences].

## Canceling Printing

Print jobs can be canceled from either a machine or computer. How to cancel print jobs differs according to their job status. Check the job status first.

### Canceling a print job already sent to the machine

Cancel the print job using the Status Monitor or pressing the [Stop] key.

### Canceling a print job that is not sent to the machine

Cancel the print job from the taskbar of the computer.

## 4

---

### Canceling Printing from the Status Monitor

---

Follow the procedure below to cancel a print job that is displayed on the Status Monitor.

1. Check that printing and the Status Monitor have started.
2. Click [Stop Printing].

It will take a few moments for printing to stop.

#### Note

- For details about Status Monitor and how to open the Status Monitor, see page 147 "Using the Status Monitor".

---

### Canceling Printing Using the [Stop] Key

---

Follow the procedure below to cancel a print job that was already sent to the machine.

The [Stop] key cancels all print jobs being printed or that were received. If you do not want to cancel another person's print job that was sent later, it's possible to delete only the current print job.

### Cancel only the print job being printed

1. Check that printing has started.

## 2. Press the [Stop] key.

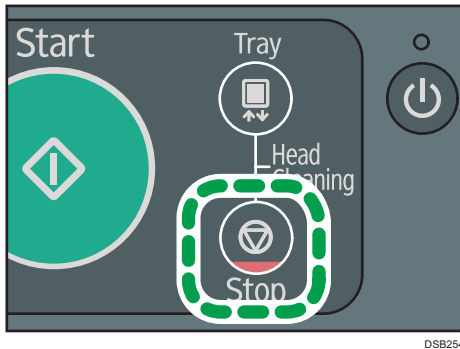

DSB254

The confirmation screen appears.

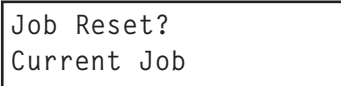

## 3. Press the [#Enter] key.

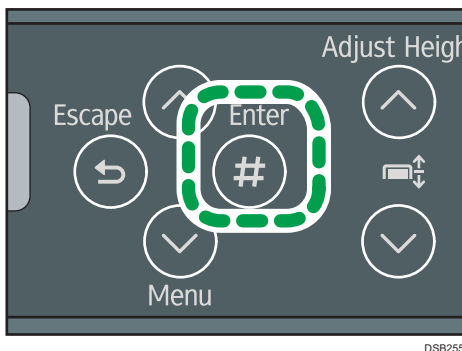

DSB255

Only the print job being printed is deleted.

If there are other print jobs waiting, they will be printed after the current print job is deleted.

It takes time to cancel the print job.

## Canceling Printing from the Taskbar

Follow the procedure below to cancel a print job in the printer queue.

1. Double-click the machine icon on the taskbar.
2. Select the print job you want to cancel, and then click [Cancel] on the [Document] menu.





# 5. Machine Setup Menus

This section describes the menu items for configuring and adjusting machine settings.

## Making Machine Settings Using the Control Panel

### Counter

You can check how many sheets have been printed.

Item
Show Counter
Print

See page 108 "Using the [Counter] Menu".

### List/Test Print

You can check the machine's present settings and operational status.

Item
Config. Page
Color Demo Page
Error Log

See page 111 "Using the [List/Test Print] Menu".

### Maintenance

You can adjust the print quality.



Item
Nozzle Check
Head-cleaning
Head-flushing
Head Position
Registration

Item	
Date/Time	
Key Repeat	Default: [On]
Feed Test	
Move Prnt-Heads	
Height Adjust	
Clean Maint Unit	
Auto Head Maint.	
Clean Internals	
Fan Filter	
Fan Speed	

See page 113 "Using the [Maintenance] Menu".

**System**

You can configure basic system settings.

Item	
Energy Saver	E.Saver Timer Default: [5 minutes]
Notify by Email	Default: [Off]
Unit of Measure	 <b>Region A</b> (mainly Europe, Asia, and China) Default: [mm]  <b>Region B</b> (mainly North America) Default: [inch]
Uni-direct.Prt.	Default: [Auto Detect]
Img Recov. Error	Default: [Display]
Display Job Name	Default: [Off]
Display Version	Printer Version
	WLAN Version

Item
Ink C.U. Space

See page 137 "Using the [System] Menu".

### Host Interface

You can configure settings related to connection and communication.

Item		
I/O Timeout	Default: [15 seconds]	
Network Setup	Machine Name	
	Host Name	
	Domain Name	
	IPv4 DNS	Default: [0.0.0.0]
	IPv4 DDNS	Default: [On]
	DHCP	Default: [On]
	IPv4 Address	Default: [11.22.33.44]
	IPv4 Subnet M.	Default: [0.0.0.0]
	IPv4 Gateway.Ad.	Default: [0.0.0.0]

Item		
Network Setup	IPv6 DDNS	Default: [On]
	IPv6 DNS	Default: [::]
	DHCPv6	Default: [Off]
	IPv6 Statlss Ad	Default: [On]
	IPv6 Address	
	IPv6 Gateway.Ad.	Default: [::]
	Active Protocol	Default: [Active]
	IPsec	Default: [Off]
	MAC Address	
	Ethernet Speed	Default: [Auto Select]
	Prmt SNMPv3 Com	Default: [Ciphertext]
	Pmt SSL/TLS Com	Default: [Active]
	Restore Default	
Wireless LAN	Connect. Status	
	Wrless Sig Stat	
	SSID	
	Security Method	Default: [WPA]
	Easy Setup	
	MAC Address	
USB Setting	USB Speed	Default: [Auto]
	Port Setting	Default: [Off]

See page 140 "Using the [Host Interface] Menu".

**Language**

You can select which language the menu is displayed in.

Item
English
German
French
Italian
Dutch
Danish
Swedish
Norwegian
Spanish
Finnish
Portuguese
Czech
Polish
Hungarian

The [Language] menu will be displayed in English.

See page 146 "Using the [Language] Menu".

**Note**

- You can prevent users other than the administrator from changing the machine's settings. For details, see page 177 "Restricting Machine Functions".

## Using the [Counter] Menu

You can check and print out the printer's counter figures.

### Show Counter

You can check on the display the number of prints made by the printer.

- **Color:**  
Indicates the total number of color originals printed using the printer driver's [Color] setting.
- **Black:**  
Indicates the total number of black and white originals printed using the printer driver's [Black and White] setting.

### Print

You can print out the printer's page counts.

- **Total Full Color**  
Indicates the total number of color originals printed using the printer driver's [Color] setting.
- **Total Black**  
Indicates the total number of black and white originals printed using the printer driver's [Black and White] setting.
- **Coverage Count.**  
Indicates the total amount (%) of ink used for the color options below:
  - **Full Color Coverage**
  - **Black Coverage**
- **Coverage 0**  
Indicates a print coverage ratio between 0 and 5%.
- **Coverage 5**  
Indicates a print coverage ratio between 5 and 20%.
- **Coverage 20**  
Indicates a print coverage ratio of 20% and higher.

### About coverage counter

"Coverage" means a coverage ratio, and a coverage ratio of 100 indicates the total amount of one ink used for all printable area on a fabric. To find a coverage ratio, compare a coverage ratio of 100 with the actual consumption of ink.

The total amount of ink indicated by a coverage ratio of 100 varies depending on ink colors.

To specify a coverage ratio per page for multiple colors, calculate the total coverage ratios of the multiple colors.

- A Full Color Coverage count:

$(\text{Full Color Coverage}) = (\text{Full Color Coverage (K)}) + (\text{Full Color Coverage (C)}) + (\text{Full Color Coverage (M)}) + (\text{Full Color Coverage (Y)})$

Ex.:

Multiple color consumption on a fabric

K: 3%, C: 8%, M: 7%, Y: 2%

$(3\% + 8\% + 7\% + 2\% = 20\%)$

Full Color Coverage: 00000020

- A coverage ratio calculation for full color printing per page:

$(\text{Full Color Coverage}) / (\text{Total Full Color})$

Ex.:

Total Full Color: 00000888

Full Color Coverage: 00007692

$7692 / 888 = 8.7\%$

Coverage Count. figures are rounded off to one decimal place.

#### Note

- Black and white files are counted as black and white prints even if color printing was specified.
- The counter numbers you can check from the [Counter] menu on the display may differ from the counter numbers that appear on the system configuration page. For details, see page 110 "Differences Between the Counter and the Total Counter".
- As the machine prints one sheet, the counter value is incremented by 1. When you set [Select Print Quality:] to [Vivid] in the printer driver or [Garment Type:] to [Thick Garment], the counter value is incremented by 2 as the machine prints one sheet.

## Displaying the Counter

This section explains how to display the counter.

1. Press the [▼/Menu] key.
2. Press [▲] or [▼/Menu] key to display [Counter], and then press the [#Enter] key.

```
<Menu>
Counter
```

3. Press [▲] or [▼/Menu] key to display [Show Counter], and then press the [#Enter] key.

```
<Counter>
Show Counter
```

4. Press [▲] or [▼/Menu] key, and then check the [Color:] and [Black:] on the display.

```
Color: 12345678
```

5. Press the [Escape] key.

---

## Printing the Counter

---

This section explains how to print the counter numbers.

1. Load the fabric in the tray.
2. Press the [▼/Menu] key.
3. Press [▲] or [▼/Menu] key to display [Counter], and then press the [#Enter] key.

```
<Menu>  
Counter
```

4. Press [▲] or [▼/Menu] key to display [Print], and then press the [#Enter] key.

```
<Counter>  
Print
```

5. Press the [#Enter] key.

```
Color:00001234  
Press # to print
```

6. Press the [Start] key.

The counter numbers will be printed.

---

## Differences Between the Counter and the Total Counter

---

The counter numbers you can check from the [Counter] menu on the display may differ from the total counter numbers that appear on the system configuration page.

The values the total counter displays include the numbers of the printed pages, test patterns, system configuration pages, or counter printouts, so the values may be greater than those on the [Counter] menu.



# Using the [List/Test Print] Menu

Use the [List/Test Print] menu to check that the machine is working properly and to also check the machine's system configuration and settings.

## Config. Page

You can print the current configuration of the machine.

## Color Demo Page

You can print color samples.

## Error Log

You can print error logs.

## Printing a Configuration Page

5

1. Load the fabric in the tray.
2. Press the [▼/Menu] key.

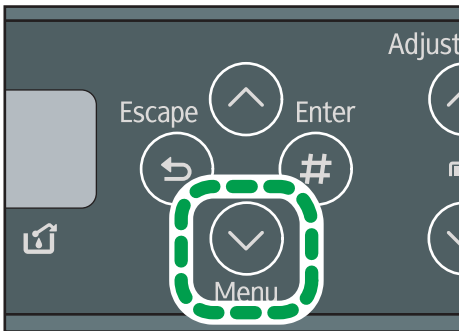

DSB253

3. Press the [▲] or [▼/Menu] key to display [List/Test Print], and then press the [#Enter] key.

```
<Menu>
List/Test Print
```

4. Press the [▲] or [▼/Menu] key to display [Config. Page], and then press the [#Enter] key.

```
<List/Test Print
Config. Page
```

5. Press the [Start] key.

The configuration page is printed.

6. Set another fabric.
7. Print all configuration pages by repeating Steps 5 and 6.

**8. Press the [Escape] key.**

---

## Interpreting the Configuration Page

---

### System Reference

Information such as the counter numbers (Pages Printed), the machine's version, printer language name, and remaining amount of ink are printed in this area.

### Maintenance

The specified settings in the [Maintenance] menu are printed in this area.

### System

The specified settings in the [System] menu are printed in this area.

### Host Interface, Interface Information

The specified settings in the [Host Interface] menu are printed in this area.

### Language

The selected language in the [Language] menu is printed in this area.

#### **Note**

- Under "System Version", the version of the machine's firmware is displayed. You can check over the Internet whether you need to update the firmware by comparing its version with that of the latest version. You can also check the firmware version by opening the [Printing Preferences] dialog box and clicking [About] on the [Configuration/About] tab.
- The number of printed pages displayed in "Pages Printed" differs from the number displayed in the [Counter] menu. See page 110 "Differences Between the Counter and the Total Counter".

# Using the [Maintenance] Menu

You can specify machine maintenance settings for adjusting print quality.

## ★ Important

- When using the [Maintenance] menu, set the tray. Otherwise, some menus are not displayed.

### Nozzle Check

Print a test pattern to check that print head nozzles become clogged.

If nozzle problems occur, print head nozzles become clogged and ink cannot be ejected properly. This will result in lower print quality.

### Head-cleaning

You can clean the print head.

Clean the head if certain colors are not printed or are printed faintly.

Head cleaning consumes ink.

### Head-flushing

You can clean the print head more thoroughly.

Because head flushing consumes more ink than head cleaning, do it only if the print head cannot be cleaned properly by head cleaning.

### Head Position

You can resolve problems such as lines that are printed vertically misaligned or blurred colors.

### Registration

Adjust the print start position of the fabric.

### Date/Time

You can specify the date and time.

### Key Repeat

The key repeat function allows you to specify setting values in units of ten or scroll the display quickly by pressing and holding down the [▲] or [▼/Menu] key.

Holding down the [Adjust Height ▲] or [Adjust Height ▼] key allows the height of the tray to be quickly adjusted.

Default: [On]

### Feed Test

Check how the tray works. Printing is not performed on the fabric.

### Move Print-Heads

Move the print head to make it easier to remove foreign objects stuck in the right edge. When all operations are completed, turn the power back on and print a [Nozzle Check] test pattern.

### Height Adjust

You can adjust the height of the tray manually.

For details about how to adjust the height using the [Adjust Height ▲] and [Adjust Height ▼] keys, see page 208 "Adjusting the Height of the Tray".

### Clean Maint Unit

Move the maintenance unit to a position where cleaning can be carried out. If the message prompting you to provide regular maintenance appears, clean the Maintenance Unit.

### Auto Head Maint.

The print head nozzles clean automatically. If the message prompting you to provide regular maintenance appears, clean the print head.

### Clean Internals

The internal compartments clean automatically. Clean the interior if you do not use the machine for a long time.

### Fan Filter

Reset the count of the number of prints after replacing the filter. See page 188 "Replacing Filters".

### Fan Speed

You can adjust the fan speed if you are bothered with the fan noise. See page 189 "Adjusting the Fan Speed".

---

## Nozzle Check

---

Follow the procedure below to check whether the print head nozzles are clogged up or not by printing a nozzle check test pattern. To maintain print quality, we recommend checking a nozzle before printing if the machine has not printed anything for a certain interval of time, such as for the first time in the day or after a rest period.

1. Load the fabric in the tray.
2. Press the [▼/Menu] key.
3. Press the [▲] or [▼/Menu] key to display [Maintenance], and then press the [#Enter] key.

<Menu> Maintenance
-----------------------

4. Press the [▲] or [▼/Menu] key to display [Nozzle Check], and then press the [#Enter] key.

<Maintenance> Nozzle Check
-------------------------------

**5. Press the [#Enter] key.**

Press # to  
print pattern

**6. Press the [Start] key.**

A test pattern is printed.

Wait while "Maintenance in process..." is displayed.

**7. Press the [Escape] key until the top screen appears.****8. Check the printed test pattern.**

Printed Test Pattern

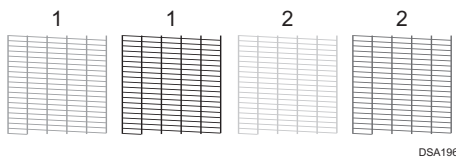

Using the test pattern, check print head clogging and the number of clogged heads.

The number appearing above each color in the test pattern is the number of the print head.

The print head for cyan and black is [Head 1].

The print head for yellow and magenta is [Head 2].

Check which print head is clogged by referring to the following illustration.

Normal

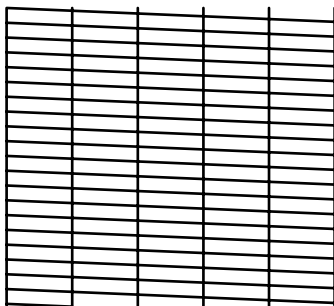

When print heads are clogged

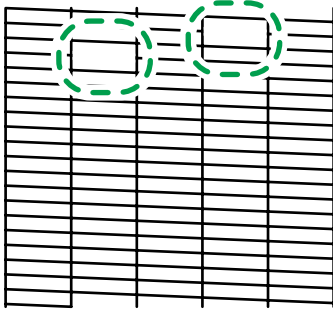

CFT169

If the print head is clogged, perform Head Cleaning. See page 116 "Head-cleaning".

If the problem persists, perform Head Flushing. See page 118 "Head-flushing".

**Note**

- This function can also be used with paper. When loading the paper on the tray, fix it to all sides of the tray with tape so that the paper does not lift up. You also need to adjust the height of the tray. For details, see page 208 "Adjusting the Height of the Tray".

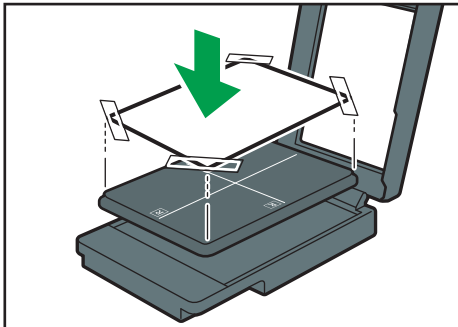

DYX111

## Head-cleaning

Follow the procedure below to perform a normal print head cleaning. Perform a head cleaning when a particular color cannot be printed or print images are blurred. Head cleaning consumes ink.

When the ink cartridge is empty, replace it instead of performing a print head cleaning. After an ink cartridge is replaced, a print head cleaning will be automatically performed.

**Important**

- Do not turn the machine off during print head cleaning. If the machine is turned off during print head cleaning, start again from the beginning.

1. Press the [▼/Menu] key.

2. Press the [▲] or [▼/Menu] key to display [Maintenance], and then press the [#Enter] key.

```
<Menu>
Maintenance
```

3. Press the [▲] or [▼/Menu] key to display [Head-cleaning], and then press the [#Enter] key.

```
<Maintenance>
Head-cleaning
```

4. Press the [▲] or [▼/Menu] key to select a color, and then press the [#Enter] key.

```
<Head-cleaning>
All Heads
```

To clean all the print heads, select [All Heads].

To clean the print head for cyan and black, select [Head 1].

To clean the print head for yellow and magenta, select [Head 2].

5. Press the [#Enter] key.

```
Press # to
clean heads
```

Head cleaning starts.

Wait while "Maintenance in process..." is displayed.

6. Press the [Escape] key until the top screen appears.

## No-fuss head cleaning

You can perform a one-touch head cleaning for all colors.

1. Press the [Tray] and [Stop] keys at the same time.

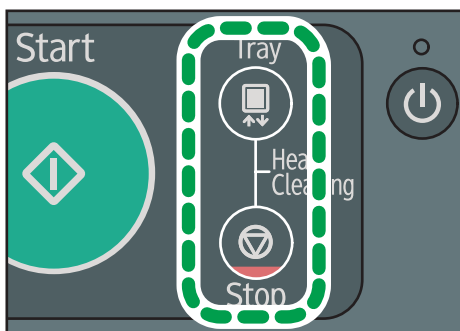

DSB256

The following message appears:

```
Press # to
clean heads
```

**2. Press the [#Enter] key.**

Head cleaning starts.

Wait while "Maintenance in process..." is displayed.

**3. Confirm that the top screen re-appears.**

## Head-flushing

Follow the procedure below to perform a thorough print head cleaning. Because head flushing consumes more ink than head cleaning, do it only if the print head cannot be cleaned properly by head cleaning.

5

When the ink cartridge is empty, replace it instead of performing a print head cleaning. After an ink cartridge is replaced, a print head cleaning will be automatically performed.

**★ Important**

- Do not turn the machine off during print head cleaning. If the machine is turned off during print head cleaning, start again from the beginning.

**1. Press the [▼/Menu] key.**

**2. Press the [▲] or [▼/Menu] key to display [Maintenance], and then press the [#Enter] key.**

```
<Menu>
Maintenance
```

**3. Press the [▲] or [▼/Menu] key to display [Head-flushing], and then press the [#Enter] key.**

```
<Maintenance>
Head-flushing
```

**4. Press the [▲] or [▼/Menu] key to select a color, and then press the [#Enter] key.**

```
<Head-flushing>
All Heads
```

To clean all the print heads, select [All Heads].

To clean the print head for cyan and black, select [Head 1].

To clean the print head for yellow and magenta, select [Head 2].



5. Press the [#Enter] key.

Press # to  
flush heads

Head flushing starts.

Wait while "Maintenance in process..." is displayed.

6. Press the [Escape] key until the top screen appears.

## Head Position

Adjusts the print head. Perform this operation if printed lines are vertically misaligned or printed colors are blurred.

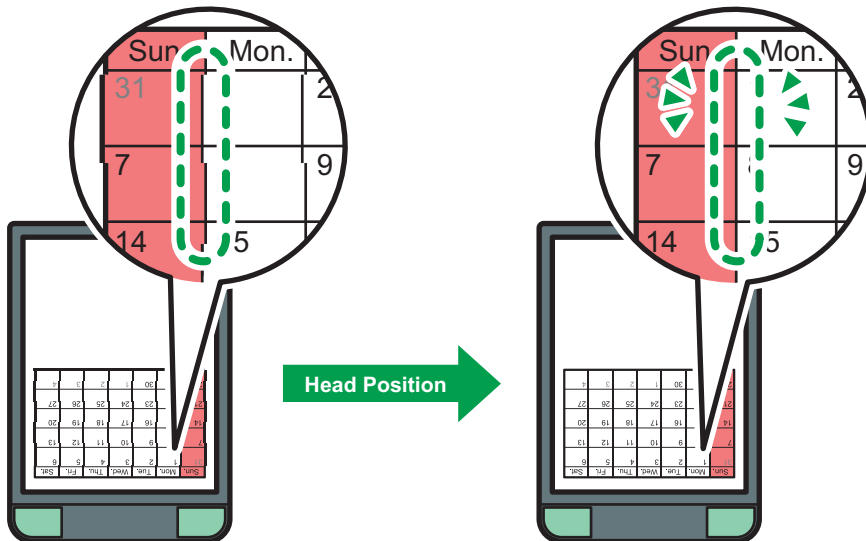

DYX110

To check adjustment values, print test patterns applying "Thick, Standard", "T-shirt Fine", "T-shirt Speed", "T-shirt Vivid" settings.

Check adjustment values for each line (A, B, C), and adjust the print head positions. If the adjustment value is set to "0", adjustment is not necessary. Adjust all lines so their adjustment values indicate "0".

1. Load the fabric in the tray.
2. Press the [▼/Menu] key.
3. Press the [▲] or [▼/Menu] key to display [Maintenance], and then press the [#Enter] key.

<Menu>  
Maintenance

4. Press the [▲] or [▼/Menu] key to display [Head Position], and then press the [#Enter] key.

```
<Maintenance>
Head Position
```

5. Press the [▲] or [▼/Menu] key to display [Pr.Test Pattern], and then press the [#Enter] key.

```
<Head Position>
Pr.Test Pattern
```

6. Press the [▲] or [▼/Menu] key to select the target's resolutions, and then press the [#Enter] key.

```
<Pr.Test Pattern
T-shirt Fine
```

7. Press the [Start] key.

A test pattern to adjust print head positions is printed.

8. To determine the adjustment value, select the square that is faintest (closest to white). Alternatively, select the square whose internal lines overlap to form a single color.

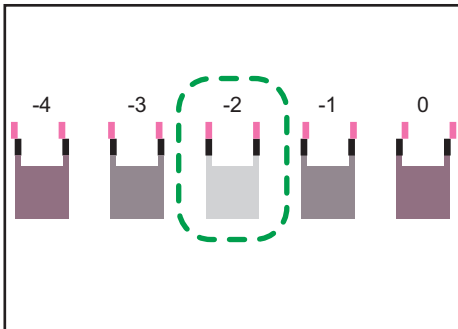

DYX104

Combined two-color lines form squares, and depending on line overlapping, (white) spaces between the lines are painted and look darker. Sometimes the colors of the lines are identical. For this illustration, the adjustment value is "-2".

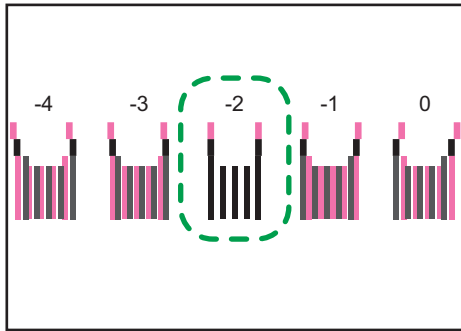

DYX105

- If you cannot determine the adjustment value, select the square that is between the straightest lines.

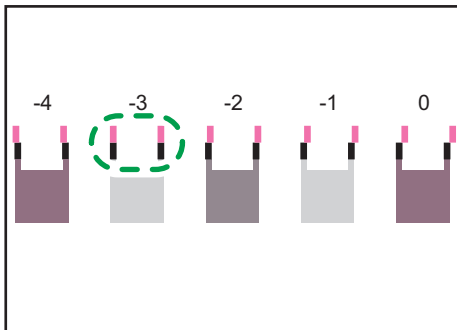

DYX106

Each vertical line is made of an upper part and lower part. If the print head is not properly positioned, the vertical line will be displayed as two disconnected lines, so that the line looks misaligned.

This illustration indicates an adjustment value of "-3".

- If you still cannot determine the adjustment value, check the deviations of the lines to the left, right, and both sides of the pale squares, and then select the square whose lines deviate symmetrically.

This illustration indicates an adjustment value of "-1".

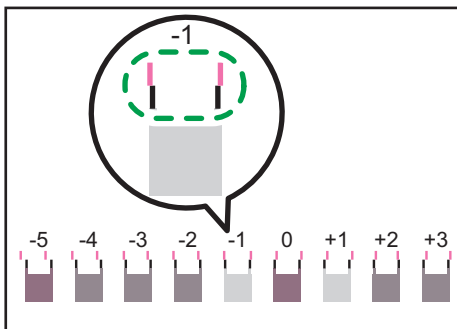

DYX107

9. Press the [▲] or [▼/Menu] key to display [Adjustment], and then press the [#Enter] key.

```
<Head Position>
Adjustment
```

10. Press the [▲] or [▼/Menu] key to select a resolution from Step 6, and then press the [#Enter] key.

```
<Adjustment>
T-shirt Fine
```

11. Select the items that you need to adjust, and then press the [#Enter] key.

```
<Adjustment>
1.A
```

12. Enter the optimal adjustment values from Step 8, and then press the [#Enter] key.

```
<A>
(-4, +4)      -1
```

13. Press the [Escape] key until the top screen appears.

#### ↓ Note

- This function can also be used with paper. When loading the paper on the tray, fix it to all sides of the tray with tape so that the paper does not lift up. You also need to adjust the height of the tray. For details, see page 208 "Adjusting the Height of the Tray".

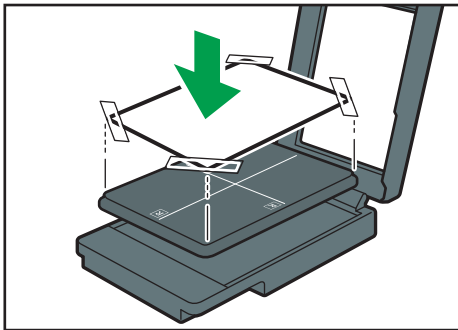

DYX111

## Registration

Print a test pattern to adjust the print start position of the fabric.

Look at the left, right, upper, and lower margins, and adjust them if you want to shift the printing position. Doing this is usually not necessary.

1. Load the fabric in the tray. Align the fabric with the corners of the table.

2. Press the [▼/Menu] key.
3. Press the [▲] or [▼/Menu] key to display [Maintenance], and then press the [#Enter] key.

```
<Menu>  
Maintenance
```

4. Press the [▲] or [▼/Menu] key to display [Registration], and then press the [#Enter] key.

```
<Maintenance>  
Registration
```

5. Press the [▲] or [▼/Menu] key to display [Pr.Test Pattern], and then press the [#Enter] key.

```
<Registration>  
Pr.Test Pattern
```

6. Press the [Start] key.

A test pattern to adjust the print start position is printed.

Check the optimal adjustment values on the printed test pattern if necessary.

7. Check the length of "a" and "b", or "x" and "y" in the figure.

Keep the fabric or paper loaded on the tray.

- When adjusting the print position in the horizontal direction  
Check the length of "a" and "b" in the figure. To shift the printed cross mark by one gradation on the scale in the "+" direction, the adjustment value in [Read Direction] should be "+1.0".
- When adjusting the print position in the vertical direction  
Check the length of "x" and "y" in the figure. To shift the printed cross mark by one gradation on the scale in the "+" direction, the adjustment value in [Feed Direction] should be "+1.0".

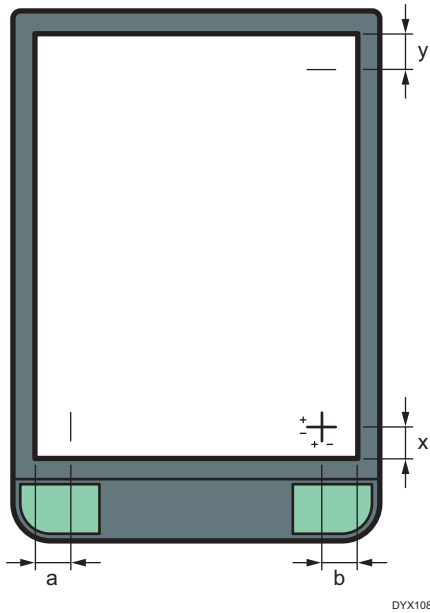

5

8. Press the [**▲**] or [**▼/Menu**] key to display [Adjustment], and then press the [**#Enter**] key.

```
<Registration>
Adjustment
```

9. Press the [**▲**] or [**▼/Menu**] key to enter the adjustment values (-4.0 to +4.0) in the [Read Direction] from Step 8, and then press the [**#Enter**] key.

```
<Read Direction>
(-4, +4) 0.0
```

10. Press the [**▲**] or [**▼/Menu**] key to enter the adjustment values (-4.0 to +4.0) in the [Feed Direction] from Step 9, and then press the [**#Enter**] key.

```
<Feed Direction>
(-4, +4) 0.0
```

11. Press the [**Escape**] key until the top screen appears.

**Note**

- This function can also be used with paper. When loading the paper on the tray, fix it to all sides of the tray with tape so that the paper does not lift up. You also need to adjust the height of the tray. For details, see page 208 "Adjusting the Height of the Tray".

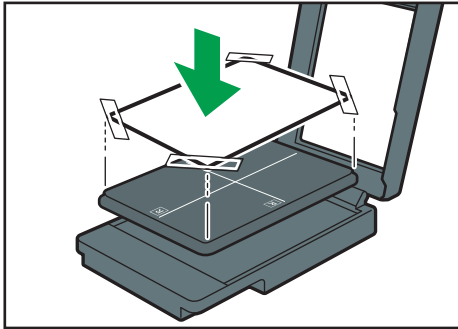

DYX111

## Setting the Date and Time

Use the following procedure to specify the date, time, and time zone.

5

### Date setting

1. Press the [▼/Menu] key.
2. Press the [▲] or [▼/Menu] key to display [Maintenance], and then press the [#Enter] key.

```
<Menu>
Maintenance
```

3. Press the [▲] or [▼/Menu] key to display [Date/Time], and then press the [#Enter] key.

```
<Maintenance>
Date/Time
```

4. Press the [▲] or [▼/Menu] key to display [Date Setting], and then press the [#Enter] key.

```
<Date/Time>
Date Setting
```

5. Press the [▲] or [▼/Menu] key to set the date, and then press the [#Enter] key.

 **Region A** (mainly Europe, Asia, and China)

```
<Date Setting>
30/ 8/2012
```

 **Region B** (mainly North America)

```
<Date Setting>
8/30/2012
```

To specify the time right after this step, go to Step 4 in "Time Setting".

See page 126 "Time setting".

**6. Press the [Escape] key.**

### Time setting

---

1. Press the [▼/Menu] key.
2. Press the [▲] or [▼/Menu] key to display [Maintenance], and then press the [#Enter] key.

```
<Menu>
Maintenance
```

3. Press the [▲] or [▼/Menu] key to display [Date/Time], and then press the [#Enter] key.

```
<Maintenance>
Date/Time
```

4. Press the [▲] or [▼/Menu] key to display [Time Setting], and then press the [#Enter] key.

```
<Date/Time>
Time Setting
```

5. Press the [▲] or [▼/Menu] key to set the time, and then press the [#Enter] key.

 **Region A** (mainly Europe, Asia, and China)

```
<Time Setting>
10:31:25
```

 **Region B** (mainly North America)

```
<Time Setting>
10:31:25 AM
```

To specify the time zone right after this step, go to Step 4 in "Time Zone Setting".

See page 126 "Time zone setting".

**6. Press the [Escape] key.**

### Time zone setting

---

1. Press the [▼/Menu] key.
2. Press the [▲] or [▼/Menu] key to display [Maintenance], and then press the [#Enter] key.

```
<Menu>
Maintenance
```



3. Press the [▲] or [▼/Menu] key to display [Date/Time], and then press the [#Enter] key.

```
<Maintenance>
Date/Time
```

4. Press the [▲] or [▼/Menu] key to display [Time Zone], and then press the [#Enter] key.

```
<Date/Time>
Time Zone
```

5. Press the [▲] or [▼/Menu] key to set the time zone, and then press the [#Enter] key.

```
<Time Zone>
GMT+00:00
```

6. Press the [Escape] key.

## Move Print-Heads

5

If a foreign object remains inside the machine, move the print head and remove it. The machine reboots when the operations are completed. Print a [Nozzle Check] test pattern to check whether the print head nozzles are clogged.

### ⚠ CAUTION

- Do not open the cover while the machine is operating and keep your hands or fingers clear of the machine. Doing so might cause your hands or fingers to get trapped in the machine, potentially causing injury.

### ★ Important

- After moving the print head and turning the power off, be sure to turn the power back on. Do not keep the print head moving.
- Do not touch the toothed rubber belt and ink tube. Moreover, pay attention not to have your sleeves caught on the ink tube or cables.

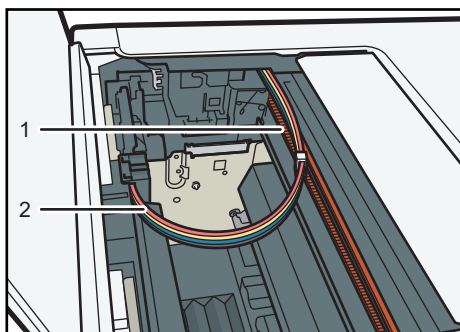

DSA504

1. Toothed rubber belt

## 2. Ink tubes

- When the cartridge runs out, the machine will not operate. After replacing the ink cartridge, perform this operation.
- Do not use tools with sharp tips to remove stuck foreign objects. Using it may cause a failure.

1. Check that the top cover is closed.
2. Press the [▼/Menu] key.
3. Press the [▲] or [▼/Menu] key to display [Maintenance], and then press the [#Enter] key.

```
<Menu>
Maintenance
```

4. Press the [▲] or [▼/Menu] key to display [Move Print-Heads], and then press the [#Enter] key.

```
<Maintenance>
Move Print-Heads
```

5. Open the top cover.
6. Remove stuck foreign objects.

Remove the foreign objects carefully.

7. Check that there are no foreign objects, and then close the top cover.

The machine turns off and on automatically, and then it returns to the usual condition.

8. Press the [▼/Menu] key.
9. Press the [▲] or [▼/Menu] key to display [Maintenance], and then press the [#Enter] key.

```
<Menu>
Maintenance
```

10. Press the [▲] or [▼/Menu] key to display [Nozzle Check], and then press the [#Enter] key.

```
<Maintenance>
Nozzle Check
```

11. Press the [Start] key.

A test pattern is printed.

Wait while "Maintenance in process..." is displayed.

12. Press the [Escape] key.

13. Check the printed test pattern.

Normal

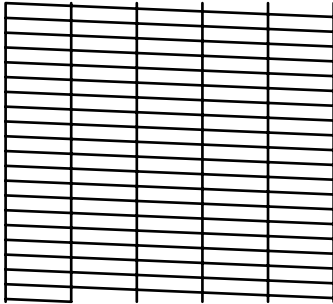

CFT168

When print heads are clogged

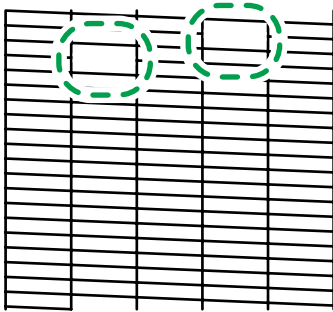

CFT169

If the print head is clogged, perform Head Cleaning. See page 116 "Head-cleaning".

## Clean Maint Unit

You can move the Maintenance Unit to the position for cleaning. If a message prompting you to provide regular maintenance appears, clean the Maintenance Unit.

### ★ Important

- Do not touch the toothed rubber belt or ink tubes when cleaning the Maintenance Unit. Also, take care not to have your sleeves caught with cables or ink tubes.
- The cleaning cloth cannot be used to clean the Maintenance Unit. Use the cleaning stick to clean it.
- If you have not cleaned the print head nozzles, proceed to clean them.
- When cleaning the Maintenance Unit, be careful not to drop the cleaning stick into the machine.

1. Press the [▼/Menu] key.
2. Press the [▲] or [▼/Menu] key to display [Maintenance], and then press the [#Enter] key.

```
<Menu>
Maintenance
```

3. Press the [▲] or [▼/Menu] key to display [Clean Maint Unit], and then press the [#Enter] key.

```
<Maintenance>
Clean Maint Unit
```

4. Press the [#Enter] key.

```
Press # to clean
Maint Unit
```

Wait while "Maintenance in process..." is displayed.

5. When "Open Top Cover to clean unit" is displayed, open the top cover.

The Maintenance Unit will move to a position where you can clean it.

The printer's power turns off automatically.

6. Wipe off any dirt in the area shown in the figure with the cleaning stick moistened with the cleaning liquid.

For the top part of the cap, wipe it gently.

5

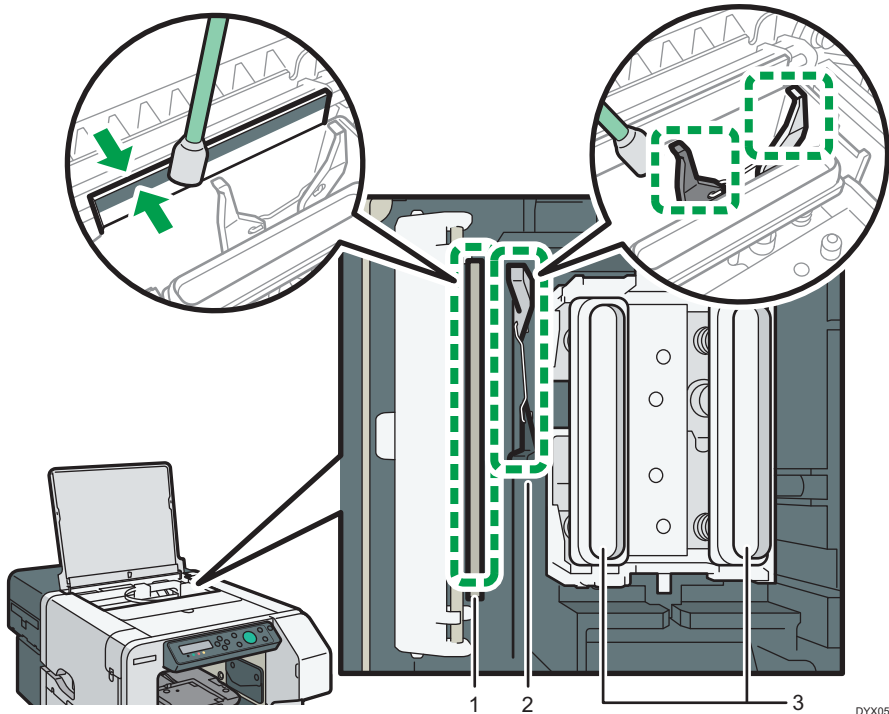

1. Wiper (back and front)
2. Lever
3. Cap (side part, top part, and inner part)

DYX055

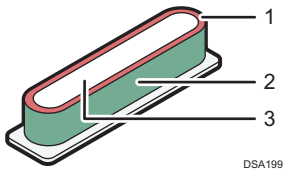

1. Top part
2. Side part
3. Inner part

Wipe the side part, top part, and inner part of the cap until all the solidified ink is removed.

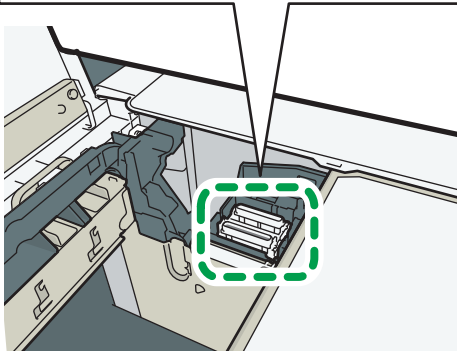
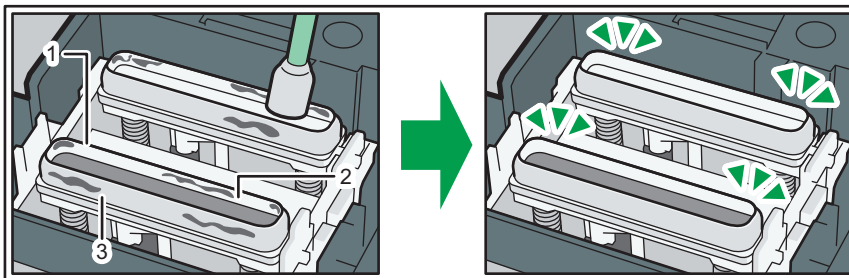

1. Top part
2. Inner part
3. Side part

The video instructions we provide also explain how to clean the Maintenance Unit. For details, see the manufacturer's website.

## 7. After cleaning the Maintenance Unit, close the top cover.

Head-cleaning starts after restart, after which the machine returns to the usual condition.

## Auto Head Maint.

You can clean the print head nozzles automatically. If the message prompting you to provide regular maintenance appears, clean the print head.

### ⚠ CAUTION

- Do not put your hands inside the machine while cleaning of the print head nozzles is automatically performed. Your fingers may be trapped and injured inside the machine.

### ★ Important

- Do not open the cover while the print head nozzles are being automatically cleaned.
- You cannot reuse the absorbent. After using it, be sure to dispose it properly.
- If you have not cleaned the maintenance unit, proceed to clean it.

1. Attach the two absorbents to the cleaning tool, and then use the dropper to moisten the absorbent with the cleaning liquid.

Use the dropper to suck cleaning liquid up to the scale 2 on the dropper. Use half of this for each absorbent swab.

Be sure to moisten the absorbent with the cleaning liquid until the absorbent is completely wet.

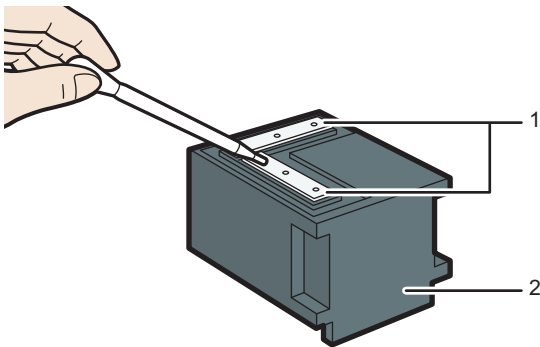

DSA255

1. Absorbent

2. Cleaning Tool

2. Press the [▼/Menu] key.
3. Press the [▲] or [▼/Menu] key to display [Maintenance], and then press the [#Enter] key.

```
<Menu>
Maintenance
```

4. Press the [▲] or [▼/Menu] key to display [Auto Head Maint.], and then press the [#Enter] key.

```
<Maintenance>
Auto Head Maint.
```

The print heads will move to a position where you can clean it.

5. Press the [#Enter] key.

```
Press # to start
maintenance head
```

6. When "Remove Tray" is displayed, remove the tray.
7. When "Set Maint. Kit Press Start key" is displayed, attach the cleaning tool to the tray stand.

Push the cleaning tool to the back until it clicks.

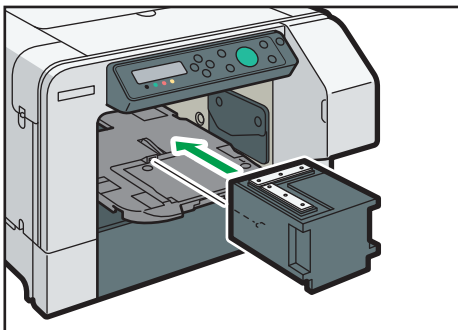

DSA104

8. Press the [Start] key.

Cleaning of the print head nozzles will start automatically. It takes 10 to 15 minutes.

Wait while "Maintenance in process..." is displayed.

9. When "Remove Maint Kit Press Start key" is displayed, detach the cleaning tool, and then press the [Start] key.

Wait while "Maintenance in process..." is displayed.

After that, the machine returns to its normal state.

10. Press the [Escape] key until the top screen appears.

## Clean Internals

The internal compartments clean automatically. Clean the interior if you do not use the machine for a long time.

When cleaning the interior, use the optional dedicated cleaning cartridge.

**⚠ CAUTION**

- Once cleaning of the interior has started, it cannot be canceled. Cleaning must be completed before the machine can be used again. Once cleaning is completed, replace the ink cartridge, turn the machine on, and provide the initial supply of ink. Once the message "Ready" appears after the initial supply of ink is provided, you can use the machine.
- When cleaning the interior, a large amount of waste fluid is generated. Moreover, when cleaning fails, a new ink cartridge or ink collector unit may be required due to additional ink consumption or waste fluid generation. Clean the interior only if you do not use the machine for three months or longer.
- When using this machine again after cleaning the interior, an initial supply of ink is required. The initially supplied ink is consumed. In order to avoid an ink shortage during the initial supply of ink and consumption of the ink cartridge, when using this machine again, attach a new ink cartridge.

5

**★ Important**

- When cleaning the interior, use a new dedicated cleaning cartridge.
  - The cleaning cartridges for each color are single use. Even if the liquid remains inside, do not use the cartridge. When reusing the cleaning cartridge, cleaning may not be completed.
  - If the Maintenance Unit is not cleaned and automatic print head maintenance is not performed, cleaning of the interior may fail. When the Maintenance Unit is not cleaned and automatic print head maintenance is not performed, carry out this maintenance before cleaning the interior. For details, see page 129 "Clean Maint Unit", page 132 "Auto Head Maint."
  - Do not operate this machine while the interior is being cleaned. Doing so may result in a cleaning failure. When the ink collector unit is full during cleaning, a message may appear. However, do not operate until cleaning is completed. Moreover, do not perform printing or access the machine from a computer.
  - When storing the machine after cleaning the interior, store it with a cleaning cartridge attached. Replace the ink cartridge using this machine again.
1. Turn the machine on.  
Confirm that "Ready" appears.
  2. Confirm that the ink collector unit has sufficient available capacity.  
When the ink collector unit is almost full or full, replace it with a new ink collector unit.  
For details, see page 184 "Replacing an Ink Collector Unit".
  3. Press the [▼/Menu] key.



- Press the [▲] or [▼/Menu] key to display [Maintenance], and then press the [#Enter] key.

```
<Menu>
Maintenance
```

- Press the [▲] or [▼/Menu] key to display [Clean Internals], and then press the [#Enter] key.

```
<Maintenance>
Clean Internals
```

- Remove the new cleaning cartridge from the box.
- Open the right front cover.
- Take out the ink cartridges.

While taking out the cartridges, be sure to hold the machine firmly so that it does not move.

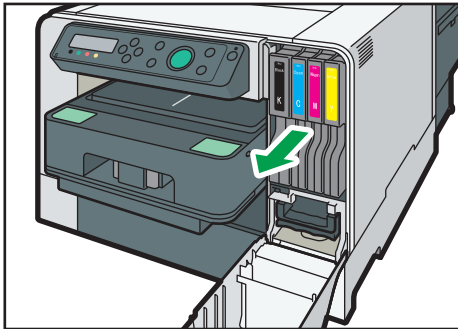

DYX044

- Check the cartridges' orientation, and then install them carefully.

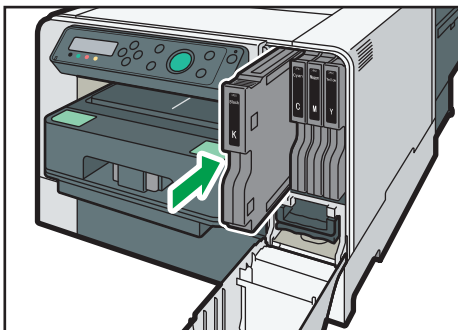

DYX046

- Close the right front cover.
- Press the [▲] or [▼/Menu] key to display [Execute], and then press the [#Enter] key.

```
<Clean Internal>
Execute
```

**12. Press the [#Enter] key.**

Press # to start Clean Internals
-------------------------------------

Insert Cleaning Cartridge
------------------------------

Cleaning of the interior will start. It takes 16 minutes to clean the interior.

Wait while "Maintenance in process..." is displayed.

**13. When "Cleaning finish Restart machine" is displayed, hold down the [Power] key to turn off the power.****When cleaning of the interior fails**

When cleaning of the interior fails, a message regarding the solution appears after the display of "Maintenance failed".

Take appropriate actions according to the message that appears.

- When "Open Front Cover / Reset Cartridge" appears, reset the cleaning cartridge correctly, and then clean the interior again.
- When "Open Front Cover / Replace Ink Crtg" appears, a cleaning cartridge which has been used once is attached. Replace it with a new cleaning cartridge, and then clean the interior again.
- When "Prepare new Ink Collector Unit" appears, replace it with a new ink collector unit, and then clean the interior again.
- Upon returning to the menu of "<Clean Internal>", raise the room temperature to 10°C (approx. 50°F) or higher, and then clean the interior again from the beginning.
- When "Right Front Cover is open / Close Right Front Cover" appears, close the right front cover, and then clean the interior again.
- When "SC(28000) Power Off On / Call Service if error reoccurs" appears without "Maintenance failed" being displayed, replace it with a new ink cartridge and clean the Maintenance Unit and perform automatic print head maintenance. Once the Maintenance Unit is cleaned and automatic print head maintenance is performed, clean the interior again from the beginning using a new cleaning cartridge.

If the problem still persists even after the actions mentioned above are taken, clean the interior again from the beginning using a new cleaning cartridge.

**Note**

- If the ink collector unit is full during cleaning, a message may appear. If the message "Cleaning finish Restart machine" appears after the cleaning operation, cleaning is successfully completed.
- After cleaning the interior, the machine can be stored for approximately one and half years within the period of the product life cycle.

# Using the [System] Menu

You can set basic functions required to use the machine. The machine can be used on factory default, but the configuration can be changed depending on the condition of the user. The changed condition holds even if the machine is turned off.

## Energy Saver

Use Energy Saver mode to reduce the machine's power consumption.

You can specify how long the machine remains idle before it switches to Energy Saver mode.

When the machine is in Energy Saver mode, it requires time to start up when it receives a print job.

You can specify between 5 and 60 minutes as the idle time before switching to the Energy Saver mode.

- 5 minutes
- 15 minutes
- 30 minutes
- 45 minutes
- 60 minutes

Default: [**5 minutes**]

## Notify by Email

You can specify whether or not to send notification that a printer error has occurred to a particular e-mail address.

Use the Web browser to specify e-mail address to send notification. See page 155 "Notifying the Machine Status by E-mail".

- On
- Off

Default: [**Off**]

## Unit of Measure

You can switch the measurement between "mm" and "inch".

- mm
- inch

 **Region A** (mainly Europe, Asia, and China)

Default: [**mm**]

 **Region B** (mainly North America)

Default: [**inch**]

## Uni-direct.Prt.

You can configure the machine to eject ink only when the head is moving in a particular direction.

Normally, the way the ink is ejected depends on the fabric type.

If you select [Always], printing is performed unidirectionally regardless of the fabric type.

By printing unidirectionally, you can eliminate differences in ink ejection timing and so prevent misregistration when printing thin lines.

If you select [Auto Detect], printing is performed according to the settings of the [Garment Type:] specified in the printer driver.

Normally, select [Auto Detect]. When printing is performed on fabrics of varied thicknesses or a vertical aberration or blurring occurs, select [Always].

- Auto Detect
- Always

Default: [Auto Detect]

### Img Recov. Error

You can specify whether or not [Page Recovery Error] is reported.

- Display
- Do not Display

Default: [Display]

### Display Job Name

The name of the job is displayed on the screen from when the job is transmitted until the [Start] key is pressed.

- On
- Off

Default: [Off]

### Display Version

Displays the firmware version.

#### Printer Version

Displays the firmware version of the machine.

#### WLAN Version

Displays the firmware version of the wireless LAN.

### Ink C.U. Space

You can check the remaining capacity of the ink collector unit.

---

## Changing the [System] Menu

---

The following procedure is an example of setting the Energy Saver mode.

1. Press the [▼/Menu] key.
2. Press [▲] or [▼/Menu] key to display [System], and then press the [#Enter] key.

```
<Menu>  
System
```

3. Press [▲] or [▼/Menu] key to display [Energy Saver], and then press the [#Enter] key.

```
<System>  
Energy Saver
```

4. Press the [#Enter] key.
5. Press [▲] or [▼/Menu] key to select the lead time needed to switch to the Energy Saver mode.

```
<E.Saver Timer>  
*5 minutes
```

6. Press the [#Enter] key.
7. Press the [Escape] key.

## Using the [Host Interface] Menu

In the [Host Interface] menu, you can specify settings related to connection and communication. Settings made using the [Host Interface] menu remain effective even if you turn the machine off.

To configure the machine's network settings, use the [Network Setup] menu.

### I/O Timeout

Specify how long the printer waits for the currently-connected interface to respond. When the specified time elapses, the machine can receive data from another interface.

If you make the I/O Timeout period too short, timeout might occur while data transfer is in progress. If this happens, the print job will be interrupted by a new job from another interface.

You can specify a timeout between 10 and 60 seconds.

- 10 seconds
- 15 seconds
- 20 seconds
- 25 seconds
- 60 seconds

Default: [15 seconds]

### Network Setup

You can make network-related settings.

#### Machine Name

Displays the machine's name.

#### Host Name

Displays the machine's host name.

#### Domain Name

Displays the machine's domain name.

#### IPv4 DNS

Specify the DNS server settings under IPv4.

If DHCP is off, enter the IPv4 addresses for the primary and secondary DNS servers in the format "xxx.xxx.xxx.xxx" (where each x represents a digit).

Default: [0.0.0.0]

#### IPv4 DDNS

Specify the setting to update the host or domain name.

- On
- Off

Default: [On]

### **DHCP**

You can specify whether or not to use DHCP in an IPv4 environment.

- On
- Off

Default: [Off]

### **IPv4 Address**

You can specify the machine's IPv4 address.

When DHCP is set to on, the IP address cannot be changed. To change it, set DHCP to off.

Contact your network administrator for information about the network configuration.

Default: [11.22.33.44]

### **IPv4 Subnet M.**

You can specify the subnet mask.

When DHCP is set to on, the subnet mask cannot be changed. To change it, set DHCP to off.

Contact your network administrator for information about the network configuration.

Default: [0.0.0.0]

### **IPv4 Gateway.Ad.**

You can specify the IPv4 gateway address.

When DHCP is set to on, the gateway address cannot be changed. To change it, set DHCP to off. Contact your network administrator for information about the network configuration.

Default: [0.0.0.0]

### **IPv6 DDNS**

Specify the setting to update the host or domain name.

- On
- Off

Default: [On]

### **IPv6 DNS**

Specify the DNS server settings under IPv6.

If DHCP is off, enter the IPv6 addresses for the primary and secondary DNS servers in the form "xxxx:xxxx:xxxx:xxxx:xxxx:xxxx:xxxx:xxxx" (where each x represents a digit).

Default: [::]

### **DHCPv6**

You can specify whether or not to use DHCP in an IPv6 environment.

- DHCPv6-Lite

- DHCPv6-Full
- Off

Default: [Off]

### IPv6 Stateless Ad

Select whether to enable or disable IPv6 stateless address auto configuration.

- On
- Off

Default: [On]

### IPv6 Address

You can specify the machine's IPv6 address.

### IPv6 Gateway Ad.

You can specify the IPv6 gateway address.

Default: [::]

### Active Protocol

Select the protocol by setting the IPv4, IPv6, HTTP (IPv4), HTTP (IPv6), and Web protocols to [Active] or [Not Active].

- Active
- Not Active

Default: [Active]

### IPsec

Specify the machine's IPsec function Active/Not Active.

- On
- Off

Default: [Off]

### MAC Address

Displays the machine's MAC address (physical address).

### Ethernet Speed

Set the access speed for networks.

Select a speed that matches your network environment. [Auto Select] should usually be selected.

- Auto Select
- 10Mbps Half D.
- 10Mbps Full D.
- 100Mbps Half D.



- 100Mbps Full D.

Default: [**Auto Select**]

### **Prmt SNMPv3 Com**

Select SNMPv3 communication for managing the machine using MIB.

- Ciphertext
- Cleartext

Default: [**Ciphertext**]

### **Pmt SSL/TLS Com**

Set SSL/TLS communication under IPv4 and IPv6 to [Active] or [Not Active]. This communication mode will be used when you specify machine settings using a Web browser.

- Active
- Not Active

Default: [**Active**]

### **Restore Default**

You can reset the network settings to their defaults.

## **Wireless LAN**

Configure settings for wireless LAN.

### **Connect. Status**

Displays the wireless LAN connection status.

- Disconnected
- Initializing
- Searching
- Connected
- Stopped

### **Wrless Sig Stat**

Displays the wireless LAN signal strength

- Good
- Fair
- Poor
- Unavailable

### **SSID**

You can display or specify an SSID.

### Security Method

You can specify the encryption of the wireless LAN.

Default: [WPA]

### Easy Setup

Select [Easy Setup] to configure the wireless LAN settings automatically. Select either [PBC Method] or [PIN Method] that is correct to network connection via the access points you can use.

### MAC Address

You can display the wireless LAN's MAC address (physical address).

### USB Setting

You can specify the settings related to communication when the computer and machine are connected via USB. Usually, you do not need to change these settings.

After changing this setting, turn the machine off, and then turn it on again.

### USB Speed

- Full Speed
- Auto

Default: [Auto]

### Port Setting

- On
- Off

Default: [Off]

---

## Changing the [Host Interface] Menu

---

This section gives an example of changing a setting in the [Host Interface] menu.

1. Press the [▼/Menu] key.
2. Press the [▲] or [▼/Menu] key to display [Host Interface], and then press the [#Enter] key.

```
<Menu>
Host Interface
```

3. Press the [▲] or [▼/Menu] key to display [I/O Timeout], and then press the [#Enter] key.

```
<Host Interface>
I/O Timeout
```

4. Press the [▲] or [▼/Menu] key to display [20 seconds], and then press the [#Enter] key.

```
<I/O Timeout>  
20 seconds
```

5. Press the [Escape] key.

---

## Precautions to Take When Using in a Network

---

### Using DHCP

- You can register the host name to a DNS server. In the Web Image Monitor menu, you can enable or disable [Notify Host Name to DHCP Server]. For details, see page 151 "Changing the Machine Settings".
- The DHCP Relay Agent is not supported.
- Supported DHCP server operating systems are: Windows Server 2008, and UNIX standard.
- The IP address acquired from DHCP can be checked on the configuration page. For details about printing a configuration page, see page 111 "Using the [List/Test Print] Menu".
- When there are multiple DHCP servers, make the same configuration for all. This printer uses information from the DHCP server that responds first.

## Using the [Language] Menu

This section explains how to select the language used for the settings and messages displayed on the display.

1. Press the [▼/Menu] key.
2. Press the [▲] key once, and then press the [#Enter] key.

```
<Menu>  
Language
```

3. Press the [▲] or [▼/Menu] key to select the language, and then press the [#Enter] key.

```
<Language>  
*English
```

5

On the display, the names of the available languages appear in English.

The message "Power Off On to Change Setting" appears.

4. Turn the machine off, and then turn it on again.

# 6. Monitoring and Configuring the Machine

This chapter describes how to monitor and configure the machine.

## Using the Status Monitor

Using the Status Monitor, you can check the print job status, error messages, amount of remaining ink and other machine status information.

You can specify how to receive notification of print job status via the Status Monitor.

1. Open the [Printing Preferences] dialog box.
2. Click the [Maintenance] tab.
3. Click [Status Monitor Settings].
4. From the list in the [Status Monitor display settings] area, select a method for launching the Status Monitor.
5. Press [OK] two times.

### Note

- For details about [Status Monitor Settings], see the printer driver Help.
- You can cancel printing from the Status Monitor. See page 100 "Canceling Printing from the Status Monitor".
- To check the amount of remaining ink, see page 178 "Replacing an Ink Cartridge".
- To check the amount of waste ink, see page 184 "Replacing an Ink Collector Unit".
- To check the error messages on the Status Monitor, see page 229 "Status Monitor Errors".

# Using Web Image Monitor

The following operations can be remotely performed using Web Image Monitor from a client computer.

- Displaying machine status or settings
- Making machine settings
- Making e-mail notification settings
- Making network protocol settings
- Performing maintenance
- Making security settings
- Resetting the machine
- Updating the machine's firmware

## Configuring the machine

To perform the operations from Web Image Monitor, TCP/IP is required. After the machine is configured to use TCP/IP, operations from Web Image Monitor become available.

6

## Recommended Web browsers

- Windows:  
Internet Explorer 6.0 or higher  
Firefox 2.0 or higher
- Mac OS:  
Safari 2.0 or higher  
Firefox 2.0 or higher

### Note

- If the previous versions of the Web browser above are used or JavaScript and cookies are not enabled with the Web browser used, display and operation problems may occur.
- Non-recommended Web browsers might not display certain screen elements correctly.
- If you are using a proxy server, change the Web browser settings. Contact your network administrator for information about the settings.
- The previous page may not appear even after the back button of a Web browser is clicked. If this happens, click the refresh button of a Web browser.

---

## Displaying Top Page

---

This section explains the Top Page and how to display Web Image Monitor.

### 1. Launch the Web browser.

## 2. In the address bar, enter "http://(machine's IP address or host name)/".

When setting SSL, a protocol for encrypted communication, under environment which server authentication is issued, enter "https://(machine's IP address or host name)/".

The displayed Web Image Monitor page is split into the following areas:

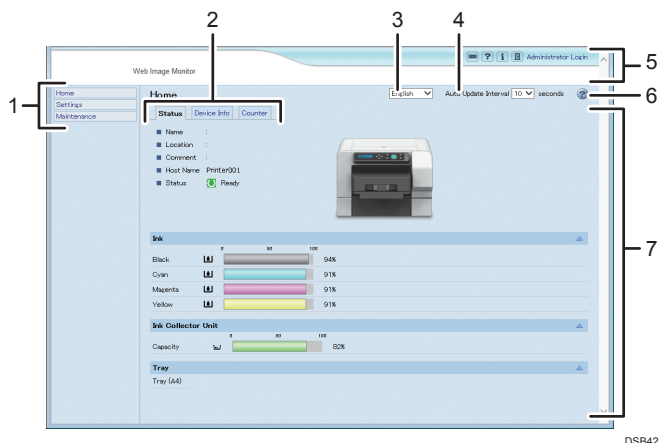

### 1. Menu Area

A menu appears.

### 2. Tab area

Details about each menu appear.

### 3. Language Selection Menu

Select a language.

If the displayed page is garbled when using an English language operating system, select "English" with the language selection menu.

### 4. Auto Update Interval

You can specify the update interval on the [Status] tab's work area.

Information for other menus and tabs are not automatically updated, so click [Refresh] to update.

Default: [10 seconds]

### 5. Header area

You can check the version of the machine's firmware by clicking . Check whether you need to update the firmware by comparing its version with that of the latest firmware via the Internet. You can change the machine settings by clicking [Administrator Login] to access the machine as an administrator.

You can check the answers to commonly asked questions and other useful information about using this machine.

Click  to view the Frequently Asked Questions. An internet connection is required to view the Frequently Asked Questions.

### 6. Help

Use Help to view Help file contents.

See page 161 "About the Web Image Monitor Help".

### 7. Main Area

Displays the contents of the item selected in the menu area.  
See page 161 "About the Web Image Monitor Help".

**Note**

- To display Web Image Monitor, click [Web Image Monitor...] on the [Configuration/About] tab in the [Printing Preferences] dialog box.

## Menu

This section explains the items in the Web browser menu.

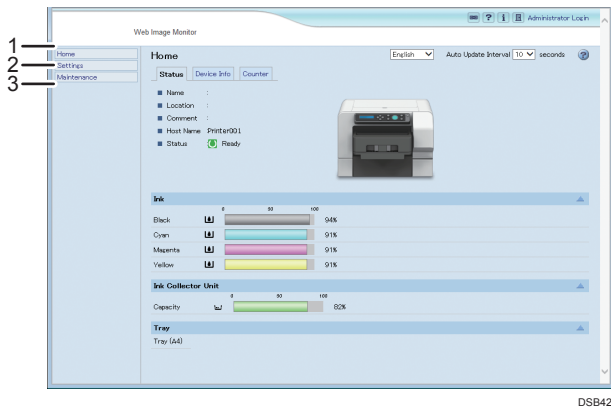

DSB426

#### 1. Home

The [Status], [Device Info], and [Counter] tab are displayed. Details of the tab menu are displayed on the work area.

#### 2. Settings

Make system settings for the machine, interface settings, and security.

#### 3. Maintenance

Click to perform printer maintenance.

## Logging in Using Web Image Monitor

To change the machine settings, log in to the machine as the administrator.

#### 1. Launch the Web browser.

#### 2. In the address bar, enter "http://(machine's IP address or host name)/".

#### 3. Click [Administrator Login].

A dialog box for entering the user name and password opens.



**4. Enter the user name and password, and then click [OK].**

If this is the first time to do this, enter "admin" as the user name and leave the password blank.

To ensure security, it is important you change the password.

**5. In the menu area, click [Settings].****6. Specify the machine settings.****7. Click [OK].**

The specified settings are transmitted to the machine.

---

## Changing the Machine Settings

---

You can specify the following settings on each page of Web Image Monitor.

**[Device Settings] area**

- [System] page
  - [General Settings]
 

You can specify [Device Name], [Comment], and [Location].
  - [Help Source File Setting]
 

You can specify [Help Source File].
- [Date/Time] page
 

You can specify [Set Date], [Set Time], [SNTP Server Address], [SNTP Polling Interval], [Time Zone], and [Daylight saving time settings].
- [Email] page
 

For details about the items and descriptions, see page 155 "Notifying the Machine Status by E-mail".
- [ROM Update] page
 

You can check the ROM firmware version and update the firmware as necessary. Download the latest update from the manufacturer's website and update the firmware according to the displayed instructions.

**[Auto Email Notification] area**

See page 155 "Notifying the Machine Status by E-mail".

**[Administrator Tools] area**

- [Administrator Authentication] page
 

You can specify [New Password] and [Confirm New Password].
- [Restore Defaults] page
 

You can restore the default settings for the network interface.

### [Interface] area

- [Interface Settings] page
  - [Ethernet]  
You can specify [Ethernet Speed].
- [Wireless LAN Settings] page
  - [Wireless LAN Settings]  
You can specify [SSID] and [Security Method].
  - [WEP Settings]  
You can specify [New WEP Key] and [Confirm WEP Key].
  - [WPA Settings]  
You can specify [WPA Encryption Method], [WPA Authentication Method], [PSK], [Confirm PSK], [User Name], [EAP Type], [Password], and [Confirm Password].
  - [Firmware Update]  
You can update the wireless LAN firmware as necessary.  
  
Download the latest update from the manufacturer's website and update the firmware according to the displayed instructions.

### [Network] area

- [IPv4] page  
You can specify whether to enable or disable [IPv4].
  - [Ethernet + Wireless LAN]  
You can specify [Host Name], [DHCP], [Notify Host Name to DHCP Server], [Domain Name], [Use Domain Name], [IPv4 Address], [Subnet Mask], and [AutoIP].
  - [Details]  
You can specify [Default Gateway Address], [DNS Server 1], [DNS Server 2], [DNS Protocol Priority], [LPR(515)], [DIPRINT(9100)], [IPP(80/631)], [WSD (Device)], [WSD (Device) Port Number], [WSD (Printer)], [WSD (Printer) Port Number], [WSD (Printer) / IPP Timeout], and [LLTD].
- [IPv6] page  
You can specify whether to enable or disable [IPv6].
  - [Ethernet + Wireless LAN]  
You can specify [Host Name], [Domain Name], [Stateless Address Autoconfiguration], and [Manual Configuration Address].
  - [Details]  
You can specify [Default Gateway Address], [DNS Server 1], [DNS Server 2], [DNS Protocol Priority], [LPR(515)], [DIPRINT(9100)], [IPP(80/631)], [WSD (Device)], [WSD

(Device) Port Number], [WSD (Printer)], [WSD (Printer) Port Number], [WSD (Printer) / IPP Timeout], and [LLTD].

- [DHCPv6] page

You can specify [DHCPv6 Operation Mode], [IAID], and [Request Timeout].

- [DDNS] page

You can specify [IPv4], [IPv6], [A Record Registration for DHCP], [AAAA Record Registration for DHCPv6], [Operation when records are duplicated], and [Interval to Update Device's Record].

- [SNMP] page

- [Protocol]

You can specify whether to enable or disable IPv4 and IPv6 when using [SNMP(161)].

- [SNMPv1,v2 Setting]

You can specify [SNMPv1,v2 Function], [SNMPv1 Trap Communication], and [SNMPv2 Trap Communication].

- [Community]

You can configure up to four SNMP communities.

- [SNMPv3] page

- [SNMPv3 Setting]

You can specify [SNMPv3 Function], [SNMPv3 Trap Communication], and [Permit SNMPv3 Communication].

- [Permit SNMPv3 Communication]

You can configure up to five SNMPv3 trap destinations.

- [Account(User)]

You can specify [Account Name(User)], [Authentication Password(User)], [Authentication Password re-enter(User)], [Encryption Password(User)], [Encryption Password re-enter(User)], and [Access Type(User)].

- [Account(Administrator)]

You can specify [Account Name(Administrator)], [Authentication Password(Administrator)], [Authentication Password re-enter(Administrator)], [Encryption Password(Administrator)], [Encryption Password re-enter(Administrator)], and [Access Type(Administrator)].

- [Bonjour] page

You can specify whether to enable or disable IPv4 and IPv6 when using [Bonjour].

- [Details]

You can specify [Computer Name] and [Location].

- [Print Order Priority]

You can specify [DIPRINT], [LPR], and [IPP].

### [Security] area

- [Network Security] page
  - [SSL/TLS Version]  
You can specify [TLS 1.1], [TLS1.0], and [SSL3.0].
  - [Encrypted Communication Settings]  
You can specify [AES], [3DES], and [RC4].
- [Access Control] page
  - [IPv4]  
You can configure up to five access control ranges.
  - [IPv6]  
You can configure up to five [Range] and [Mask] settings.
- [IPP Authentication] page  
You can configure up to ten [Authentication], [User Name], and [Password] settings.
- [SSL/TLS] page  
You can specify [SSL/TLS(443)] and [Permit SSL/TLS Communication].
- [Site Certificate] page
  - [Imported Site Certificate]  
You can select [Delete] or [Update to Trustworthy Certificate] for an imported site certificate.
  - [Site Certificate to Import]  
Import the site certificate according to the displayed instructions.
- [Device Certificate] page  
You can select [Create], [Request], [Install], [Install intermediate Certificate], [Delete/Cancel Request], and [Delete intermediate Certificate] for up to three certificates.
  - [Certification]  
Select the certificate to be used in [SSL/TLS], [Wireless LAN], and [IPsec].
- [IPsec] page  
You can specify [IPsec].  
You can configure up to ten parameters.

### [@Remote] area

- [Remote Communication Gate Setup] page

You can specify the [Request No.] to be used in [Confirm] and [Program] for Remote Communication Gate. When the [Status] is set to [Registered], the [Request No.] used for the registration is displayed.

- [Remote Communication Gate Proxy Server] page

You can specify whether to enable or disable the [Remote Communication Gate Proxy Server].

You can specify [Proxy Address], [Port Number], [User Name], [Password], and [Confirm Password].

## Notifying the Machine Status by E-mail

You can be notified of the machine status by e-mail on an occasion such as when a print error occurs.

The e-mail notifying the machine status will be sent to the e-mail address specified as the destination in advance. You can also specify the timing and status to notify.

### ★ Important

- **Depending on your e-mail application, a phishing warning message might appear when you receive e-mail. To stop this warning message appearing, see your e-mail application's Help for details about registering trusted senders.**

To receive reports of the machine's status by e-mail, set [Notify by Email] to [On] in the [System] menu, and then specify an e-mail address and other required settings using Web Image Monitor. The [Auto Email Notification] setting can be changed only by the administrator.

The following status can be notified:

- The printer error has occurred.
- The ink has run out.
- The ink will run out soon.
- The Ink Collector Unit must be replaced now.
- The Ink Collector Unit must be replaced soon.
- The fabric was jammed.
- The tray size is wrong.
- A cover is open.
- The specified part such as an ink cartridge is not installed correctly.
- The machine is out of its operational temperature range.
- The total number of printed pages.

### ↓ Note

- For details about Notify by Email, see page 137 "Using the [System] Menu".

- How to log in as the administrator, see page 150 "Logging in Using Web Image Monitor".

## Specifying notification the printer status by e-mail

---

On the [Email] page, you can specify the basic and authentication settings for sending e-mail.

You can enable or disable Auto Email Notification. The "Administrator Email Address" will appear in the e-mail message. The "Device Email Address" will appear in the "From" box.

### [Auto Email Notification]

You can specify whether to enable or disable this function.

Default: [Inactive]

### [Device Email Address]

Enter the device's e-mail address using up to 127 characters.

Default: Blank

### [Administrator Email Address]

Enter the administrator's e-mail address using up to 127 characters.

Default: Blank

### [Email Body]

Enter messages using up to 255 characters.

Default: Blank

### [SMTP]

You can specify the SMTP server name and SMTP Port No.. By specifying the SMTP authentication setting, you can send e-mails to destinations where the e-mail server carries out SMTP authentication.

By specifying the SMTP authentication setting, you can log on to SMTP servers which require authentication. The supported authentication protocols are: CRAM MD5, PLAIN, and LOGIN.

- [SMTP Server Name]

Enter the server name using up to 127 characters.

Default: Blank

- [SMTP Port No.]

Default: [25]

- [SMTP AUTH]

You can specify whether to enable or disable this function.

Default: [Inactive]

- [SMTP Auth. User Name]

Enter the user name using up to 191 characters.

Default: Blank

- [SMTP Auth. Password]

Enter the password using up to 63 characters.

Default: Blank

- [Confirm SMTP Auth. Password]

Enter the password using up to 63 characters.

Default: Blank

- [SMTP Auth. Encryption]

If you select [Auto Select], the printer logs on using DIGEST MD5, CRAM MD5, NTLM Authentication, LOGIN, and then PLAIN.

If you select [On], the printer logs on using DIGEST MD5, CRAM MD5, and then NTLM Authentication.

If you select [Off], the printer logs on using LOGIN and then PLAIN.

Default: [**Auto Select**]

## [POP before SMTP]

By specifying the SMTP authentication setting, you can send e-mails to destinations where the e-mail server carries out SMTP authentication.

By using POP before SMTP, you can log on to an SMTP server supporting POP before SMTP.

You can specify whether to use POP before SMTP, and specify the POP server name, POP port number, POP user name, and POP password.

- [POP before SMTP]

You can specify whether to enable or disable this function.

Default: [**Inactive**]

- [POP User Name]

Enter a user name using up to 127 characters.

Default: Blank

- [POP Password]

Enter a password using up to 63 characters.

Default: Blank

- [Confirm POP Password]

Enter a password using up to 63 characters.

Default: Blank

- [POP Auth. Encryption]

If you select [Auto Select], the printer logs on by APOP login, and then in plain text.

If you select [On], the printer logs on only by APOP login.

If you select [Off], the printer logs on only in plain text.

Default: [**Auto Select**]

- [Timeout setting after POP Auth.]

In standby time following POP authentication (in milliseconds), you can specify how long the printer can wait for logging on to the SMTP server after logging on to the POP server.

Default: [**300 milli-second**]

#### [POP3/IMAP4]

- [POP Server Name]

Enter the server name using up to 127 characters.

Default: Blank

#### [Email Reception Port]

- [POP3 Reception Port No.]

Default: [**110**]

### Auto Email Notification: Error Notification by Email: Group 1-3

---

#### [Groups to Notify]

- [Group Name]

Enter a group name using up to 19 characters.

Default: Blank

- [Email Language]

You can select the language used for e-mail.

Default: [**English**]

- [Subject]

Enter a subject using up to 31 characters.

Default: Blank

- [Message]

Enter a message using up to 255 characters.

Default: Blank

#### [Notify]

- [Notify 1-5]

Enter up to 19 characters for [Name] and up to 127 characters for [Email Address].

Default: Blank



**[Error Items to Notify]**

Select which errors are sent as e-mail notifications.

- [Error: Printer]
- [Out of Ink]
- [Low Ink]
- [Replace Ink Collector Unit]
- [Prepare new Ink Collector Unit]
- [Garment Misfeed]
- [Size Mismatch]
- [Cover Open]
- [Unit/Cartridge Not Set]
- [Device cannot be used in this temperature conditions.]

Default: Not selected

**Auto Email Notification: Counter Notification: Group**

6

**[Groups to Notify]**

- [Email Language]

You can select the language used for e-mail.

Default: **[English]**

- [Subject]

Enter a subject using up to 31 characters.

Default: Blank

**[Notify]**

- [Notify 1-5]

Enter up to 19 characters for [Name] and up to 127 characters for [Email Address].

Default: Blank

**[Notification Item]**

- [Total Pages Printed]

Default: Not selected

**Auto Email Notification: Detailed Settings for Error Notification****[Error: Printer]**

- [Notify when error:]

Default: **[Occurs]**

- [Notify within:]

Default: **[0 minute(s)]**

**[Out of Ink]**

- [Notify when error:]

Default: **[Occurs]**

- [Notify within:]

Default: **[0 minute(s)]**

**[Low Ink]**

- [Notify when error:]

Default: **[Occurs]**

- [Remaining]

Default: **[10 %]**

**[Replace Ink Collector Unit]**

- [Notify when error:]

Default: **[Occurs]**

- [Notify within:]

Default: **[0 minute(s)]**

**[Prepare new Ink Collector Unit]**

- [Notify when error:]

Default: **[Occurs]**

- [Remaining]

Default: **[10 %]**

**[Garment Misfeed]**

- [Notify when error:]

Default: **[Occurs]**

- [Notify within:]

Default: **[0 minute(s)]**

**[Size Mismatch]**

- [Notify when error:]

Default: **[Occurs]**

- [Notify within:]

Default: **[0 minute(s)]**

**[Cover Open]**

- [Notify when error:]  
Default: [**Occurs**]
- [Notify within:]  
Default: [**0 minute(s)**]

**[Unit/Cartridge Not Set]**

- [Notify when error:]  
Default: [**Occurs**]
- [Notify within:]  
Default: [**0 minute(s)**]

**[Device cannot be used in this temperature conditions.]**

- [Notify when error:]  
Default: [**Occurs**]
- [Notify within:]  
Default: [**0 minute(s)**]

**Auto Email Notification: Counter Notification****[Total Pages Printed]**

- [Method to Notify]  
Default: [**Number of Pages**]
- [Interval]  
Default: [**100 Per Page**]
- [Date to Notify]  
Default: [**1**]

**About the Web Image Monitor Help**

You can view help on the things you can do through Web Image Monitor.

**When you can access the Internet:**

1. **Launch the Web browser.**
2. **In the address bar, enter "http://(machine's IP address or host name)/".**
3. **Click .**

The Help top page appears.

If you click  on the displayed page, you can view Help for that page.

**When you cannot access the Internet:**

1. Insert the driver CD into the CD-ROM drive.
2. Click [Browse This Disk].
3. Double-click the WIMHELP folder.
4. Copy the language folder and save it on your computer.
5. Open the language folder that you saved.
6. Open the index.html.

# SNMP

The Ethernet interface includes the Simple Network Management Protocol (SNMP) agent for UDP.

Using the SNMP manager, you can obtain printer data.

The default community name is "public". Using this community name, you can obtain MIB data.

## Supporting MIB

### SNMPv1/v2c/SNMPv3

- MIB-II
- PrinterMIB
- HostResourceMIB
- RicohPrivateMIB
- PrinterPortMonitorMIB
- IP Forwarding Table MIB

### SNMPv3

- SNMPv2-MIB
- SNMP-FRAMEWORK -MIB
- SNMP-MPD-MIB
- SNMP-TARGET-MIB
- SNMP-NOTIFICATION-MIB
- SNMP-USER-BASED-SM-MIB
- SNMP-VIEW-BASED-AMC-MIB
- SNMP-COMMUNITY-MIB



# 7. Using the Machine with a Macintosh

---

This chapter describes how to use the machine with a Macintosh.

## System Requirements for Macintosh

The machine is compatible with Mac OS X 10.8 and later versions.

The operating environment for the printer driver depends on the application in use.

OS X Server is not supported.

### Note

- You can only use a network printer via a TCP/IP connection. You cannot use AppleTalk.

# Instructions Applicable to Both Macintosh and Windows Computers

The instructions in the following sections apply to both Windows and Macintosh computers.

## **Checking the machine status and settings**

See page 111 "Using the [List/Test Print] Menu".

## **Specifying the interface and network settings**

See page 140 "Using the [Host Interface] Menu".

## **Usable fabric and precautions regarding fabric**

See page 70 "Fabric".

## **Loading fabrics**

See page 72 "Loading Fabrics".

## **Specifying the machine's settings using a web browser**

See page 148 "Using Web Image Monitor".

## **Checking the number of printed pages**

See page 108 "Using the [Counter] Menu".

## **Adjusting the print quality**

See page 113 "Using the [Maintenance] Menu".

## **Specifying system settings**

See page 137 "Using the [System] Menu".

## **Selecting the display language**

See page 146 "Using the [Language] Menu".

## **Restricting machine functions**

See page 177 "Restricting Machine Functions".

## **Replacing an ink cartridge**

See page 178 "Replacing an Ink Cartridge".

## **Replacing an ink collector unit**

See page 184 "Replacing an Ink Collector Unit".

## **Cleaning**

See page 190 "Cleaning".

## **Moving**

See page 195 "Moving".



**Disposing**

See page 197 "Disposing".

**When not using for a long period of time**

See page 198 "When Not Using for a Long Period of Time".

**Printing will not start**

See page 205 "Printing Does Not Start".

**Tray does not operate normally**

See page 207 "The Tray Does Not Operate Correctly".

**Print results are not satisfactory**

See page 215 "Print Results Are Not Satisfactory".

**Error & status messages on the display**

See page 223 "Error & Status Messages on the Display".

**Software on the CD-ROM**

See page 239 "Software on the CD-ROM".

# Installing the Printer Driver on a Macintosh

This section explains how to install the printer driver on a Macintosh and then register the printer in accordance with the type of connection.

The following procedures are based on Mac OS X 10.11. The procedures for your machine might differ slightly from those shown if you are using a different version of Mac OS.

## ★ Important

- You cannot install the printer driver while other applications are running. Be sure to close all applications before installing the printer driver.
- To install the printer driver, you must log on as administrator. For details, consult the administrator of the Macintosh in question.

1. Insert the driver CD in the CD-ROM drive.
2. Double-click the [macOS] folder.
3. Double-click the [RPCS\_R] folder.
4. Double-click the "product name.pkg" icon.
5. Click [Continue] three times.
6. Click [Agree].
7. Select the install location, and then click [Continue].
8. Click [Install].  
To select where to install the file, click [Change Install Location...].
9. Enter the administrator's user name and password, and then click [Install Software].
10. Click [Close].

---

## Adding the Printer through a USB Connection via the Printers & Scanners Preferences Pane

---

## ★ Important

- Connect the machine to the USB port in advance and turn it on.
1. On the [Apple] menu, click [System Preferences...], and then click the [Printers & Scanners].
  2. From the list of printers, select a printer that is automatically recognized by plug-and-play, and then click [−] to delete it.
  3. Click [Delete Printer].
  4. Click [+].

5. Click [Default], and then make sure [Kind] is set to [USB].
6. Select the name of the printer you want to use.
7. Make sure the product name appears in the [Name] field, and then click [Add].  
The name of the added printer appears in [Printers & Scanners].
8. Click [×].

---

## Adding the Printer in the Printers & Scanners Panel Using Bonjour

---

You can configure the machine to print using Bonjour. You can connect to the machine either by Ethernet or wireless LAN.

### ★ Important

- Before printing, be sure to set [Bonjour] to [Active] using Web Image Monitor.
1. On the [Apple] menu, click [System Preferences...], and then click the [Printers & Scanners].
  2. Click [+].
  3. Click [Default], and then select the printer. Make sure [Kind] is set to [Bonjour].
  4. Make sure the product name appears in the [Name] field, and then click [Add].  
The name of the added printer appears in [Printers & Scanners].
  5. Click [×].

---

## Adding the Printer through a Network Connection via the Printers & Scanners Preferences Pane

---

### ★ Important

- Connect the machine to the network in advance and turn it on.
  - Specify the machine's IP address on its control panel in advance.
1. On the [Apple] menu, click [System Preferences...], and then click the [Printers & Scanners].
  2. Click [+].
  3. Click [IP].
  4. From the [Protocol:] menu, select [HP Jetdirect - Socket].
  5. In the [Address:] field, enter the IP address or the host name of the printer you want to use.
  6. Select [Select Software...] in the [Use:] field.

- 7. Select the name of the printer you want to use in the list, click [OK], and then click [Add].**  
The IP address of the added printer appears in [Printers & Scanners].
- 8. Click [×].**

# Maintenance of the Machine Using a Macintosh

You can perform the maintenance of the machine using a Macintosh.

For details about maintenance, see page 113 "Using the [Maintenance] Menu".

---

## Displaying the [Maintenance Utility] on a Macintosh

---

1. On the [Apple] menu, click [System Preferences...], and then click the [Printers & Scanners].
2. Select the printer you want to use, and then click [Options & Supplies...].  
If you want to use a network printer, select the IP address or the host name of the printer.
3. Click [Utility] and [Open Printer Utility].

If [Maintenance Utility] is displayed, bidirectional communication is available.

### Note

- For details about the [Maintenance Utility], see the printer driver Help.

## Printing with a Macintosh

This section explains how to load a fabric in the tray and print on it.

How to open the printer properties pane on a Macintosh depends on the application in use.

For details, see the application's manual.

### 1. Load on the tray stand the tray in which the fabric has been loaded.

How to load the fabric depends on the fabric type. See page 72 "Loading Fabrics".

If you want to change the print condition settings for the media size, print mode, color mode, and color profile, you need administrator's privileges.

You must log on as a member of the administrators group. If you do not want to change the print condition settings, proceed to Step.8.

### 2. Open the Terminal application and input the command "> cupsctl WebInterface=yes".

### 3. Access a web browser and enter localhost: 631 in the address bar.

### 4. From the [Printers] tab, select the printer you want to use.

If you want to use a printer connected to the network, select the printer according to its IP address.

From the menu where application names (such as Preview) are displayed, you can select items such as [Printer Features].

If necessary, change the settings of each item.

### 5. Select [Set Default Options] from the Administration drop-down list in the displayed screen.

### 6. Specify the settings for Media Size, Print Mode, and Color Mode in the General screen.

### 7. Specify the settings for Color profile in the Image Adjustments screen.

### 8. From the application's File menu, select [Print...].

### 9. From the [Printer:] menu, select the printer you want to use.

If you want to use a printer connected to the network, select the printer according to its IP address.

From the menu where application names (such as Preview) are displayed, you can select items such as [Printer Features].

If necessary, change the settings of each item.

### 10. Click [Print].

### 11. Press the [Start] key on the machine.

#### ↓ Note

- The vertical and horizontal resolutions will be the same.
- For precautions on handling fabric, see page 70 "Precautions Regarding Fabric".
- For details about the printable area of a fabric, see page 71 "Printable area".

- Depending on the application, the setting contents of the printer driver may be automatically changed.
- For details on how to handle the tray, see page 22 "Loading and Removing the Tray".
- For usable fabric types and precautions, see page 70 "Fabric".

## Canceling Printing on a Macintosh

You can cancel a print job from either the machine or the computer.

### Canceling a print job from the machine

You can cancel the print job by pressing the [Stop] key.

See page 100 "Canceling Printing Using the [Stop] Key".

### If the computer has not yet sent the print job to the printer

If you execute the print command, the print job queue window opens and the print job is queued. Using the print job queue window, you can cancel print jobs.

See page 174 "Canceling a Print Job from the Print Job Queue Window".

---

## Canceling a Print Job from the Print Job Queue Window

---

You can delete a print job before, during, and after its being sent from the computer to the printer.

1. Check that the print job queue window opens.
2. In the print job queue window, select the print job you want to cancel.
3. Click [×].



# Opening Help on a Macintosh

Help is useful for learning about what the various settings do and how to specify them.

1. On the [Apple] menu, click [System Preferences...], and then click the [Printers & Scanners].
2. Select the printer you want to use, and then click [Open Print Queue...].  
If you want to use a network printer, select the IP address or the host name of the printer.
3. On the [Help] menu, click the help showing your printer's name.



# 8. Maintenance

This chapter describes how to maintain and operate the machine.

## Restricting Machine Functions

This section explains how to lock keys on the control panel to prevent general users from changing settings and performing certain functions.

By locking certain control panel keys, you can prevent users other than the administrator from doing the following:

- Pressing the [▼/Menu] key to display the menu
- Press the [Tray] and [Stop] keys at the same time to perform the no-fuss head cleaning
- Pressing the [Stop] key to cancel print jobs
- Pressing the [Power] key to turn the machine off

### Locking the Keys

Use this procedure to lock the control panel keys.

1. Simultaneously press and hold down the [▼/Menu], [Escape], and [#Enter] keys for 3 seconds, and then [#Enter] key two times.

#### ↓ Note

- If you press a locked key, "Panel Locked/Cannot use" appears.
- If an error occurs while the keys are locked, certain keys are automatically unlocked to allow you to clear the error.

### Unlocking the Keys

Use this procedure to unlock the control panel keys.

1. Simultaneously press and hold down the [▼/Menu], [Escape], and [#Enter] keys for 3 seconds, and then [#Enter] key two times.

#### ↓ Note

- Unlock the keys if an error occurs and the "Panel Locked/Cannot use" message appears.

## Replacing an Ink Cartridge

### ★ Important

- If the ink cartridge has been empty for a long time, you will not be able to perform the maintenance for the print head. This may cause a printer malfunction. Make sure you always have a new ink cartridge. Install it soon after the message about replacement appears.

## Checking the Remaining Ink

Follow the procedure below to check when to replace ink cartridges using the Status Monitor or the cartridge replacement indicators.

### Checking the remaining ink level on the display

You can check the remaining ink level by looking at the icon that appears above the cartridge replacement indicator.

K, C, M, and Y indicate black, cyan, magenta, and yellow, respectively.

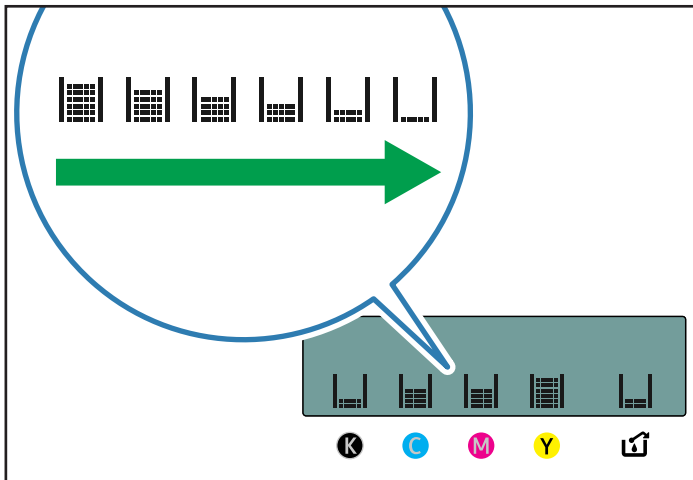

CHU012

If the ink will soon run out, the message "Low Ink" appears on the display.

Make sure you have a new ink cartridge for the color indicated by the  icon.

If an ink cartridge runs out of ink, the message "Open Front Cover / Replace Ink Crtg" appears on the display.

Replace the ink cartridge for the color indicated by the  or  icon.

## Checking the remaining ink level on the Status Monitor

The cartridge status can be used to check when to replace the cartridge.

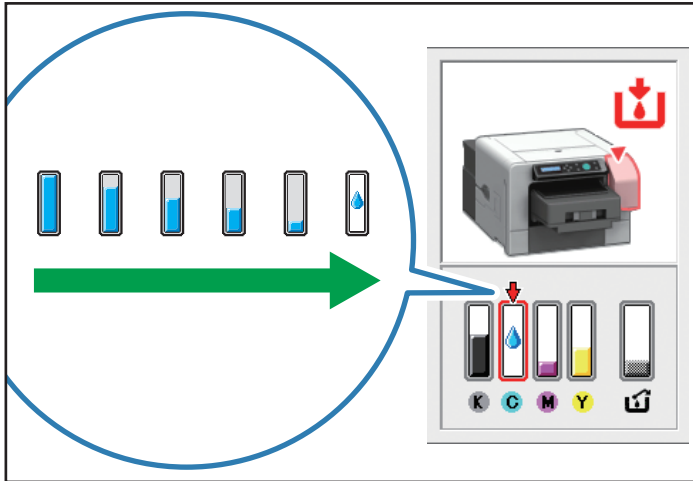

DSA429

1. Open the [Printing Preferences] dialog box.
2. Click the [Maintenance] tab.
3. Click [Display Status Monitor].
4. Check the cartridge status.

### ↓ Note

- You can specify that the Status Monitor send a notification when the ink will soon run out. To do this, open the printer driver dialog box, click [Status Monitor Settings] on the [Maintenance] tab, and then select the [Notify cartridge replacement] check box.
- Be sure to insert the ink cartridges correctly. If you insert them incorrectly, Status Monitor might not be able to detect the amount of ink that is remaining in the cartridges. See page 182 "Handling Ink Cartridges".

## Replacing an Ink Cartridge

If an error occurs in the printer, resolve it, and then replace the ink cartridge.

### ⚠ CAUTION

- Keep ink and ink containers out of reach of children.
- If ink gets into contact with eyes, wash eyes immediately with running water. Consult a doctor if necessary.

## **⚠ CAUTION**

- When replacing ink, avoid getting ink on your clothing. If ink comes into contact with your clothing, wash the stained area with cold water. Hot water will set the ink into the fabric and make removing the stain impossible.
- When replacing ink, avoid getting ink on your skin. If ink comes into contact with your skin, wash the affected area thoroughly with soap and water.
- When removing the ink cartridge, avoid putting your hand near the place where the ink cartridge is installed. If ink comes in contact with your hands, wash them thoroughly with soap and water.

## **★ Important**

- When removing the ink cartridge, do not touch the inside of the machine.
- Carefully install a cartridge in the correct position.
- Do not push the right front cover to insert the ink cartridge when replacing it.

1. Take the ink cartridge out of the box.
2. Open the right front cover.

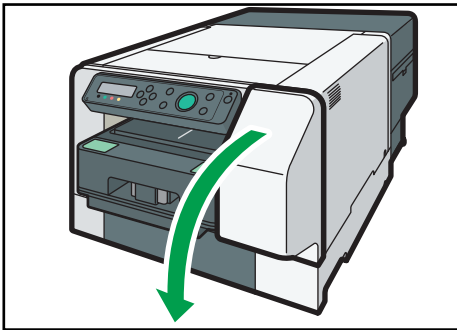

DYX030

3. Take out the empty cartridges.

While taking out the cartridges, be sure to hold the machine firmly so that it does not move.

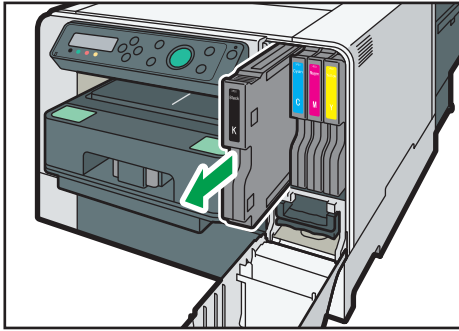

DYX047

**4. Check the cartridges' orientation, and then install them carefully.**

Install in the following order from the left: black, cyan, magenta, and yellow.

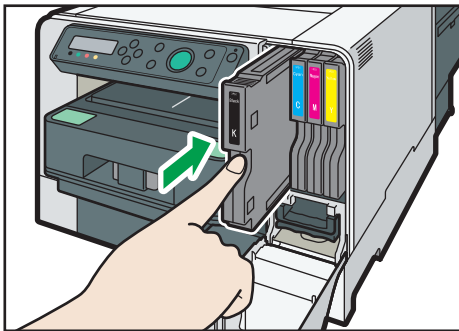

DYX051

**5. Push each cartridge fully in.**

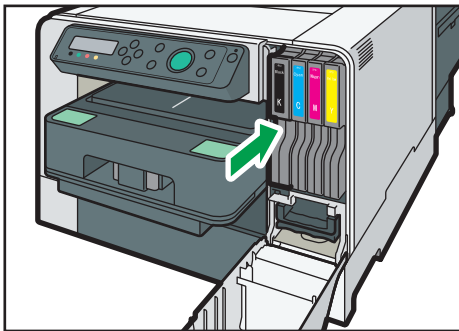

DYX052

**6. Close the right front cover.**

Make sure that the ink cartridge has been fully pushed in before closing the right front cover.

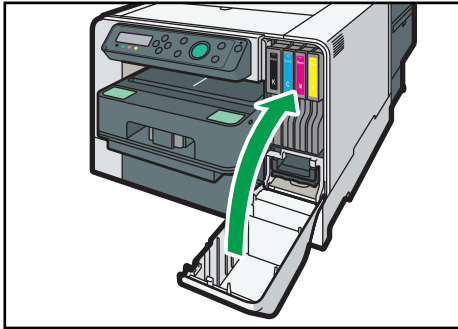

## Handling Ink Cartridges

Important points about handling ink cartridges are explained.

### **⚠ WARNING**

- The following explains the warning messages on the plastic bag used in this product's packaging.
  - Keep the polythene materials (bags, gloves, etc.) supplied with this machine away from babies and small children at all times. Suffocation can result if polythene materials are brought into contact with the mouth or nose.

### **⚠ CAUTION**

- Keep ink and ink containers out of reach of children.
- If ink gets into contact with eyes, wash eyes immediately with running water. Consult a doctor if necessary.
- When replacing ink, avoid getting ink on your clothing. If ink comes into contact with your clothing, wash the stained area with cold water. Hot water will set the ink into the fabric and make removing the stain impossible.
- When replacing ink, avoid getting ink on your skin. If ink comes into contact with your skin, wash the affected area thoroughly with soap and water.
- When removing the ink cartridge, avoid putting your hand near the place where the ink cartridge is installed. If ink comes in contact with your hands, wash them thoroughly with soap and water.

### About ink cartridges

- Ink cartridges comply with the manufacturer's safety specifications. To ensure safety and reliability, use genuine ink cartridges.



- When using the machine for the first time, install genuine ink cartridges.
- Do not reuse the ink cartridges.

### Using ink cartridges

- Ink cartridges should be used up before their expiry date, ideally within three months of being removed from their packaging.
- Do not open the package of an ink cartridge until the cartridge will be installed in the machine.
- Do not touch the ink cartridges' ink inlets or chip contacts.
- Do not shake ink cartridges strongly. Ink may leak out.
- Do not take apart ink cartridges.
- Do not open the right front cover except when installing ink cartridges. Do not turn off the power or unplug the power cord during the process of installing the cartridges.
- Always confirm the color of an ink cartridge before installing it.
- Do not remove an ink cartridge once it has been installed unless necessary.
- Do not remove an ink cartridge while printing is being performed. Printing will stop.

### Storing ink cartridges

- Store ink cartridges at a temperature of between -30 and +40°C (-22 to 104°F).

### Ink consumption

- To protect the print head and ensure print quality, the machine performs periodic maintenance and print head cleaning when it is turned on. Both operations consume ink.
- The amount of ink consumed during cleaning depends on the cartridge size.

#### Note

- If you intend to use the machine after it has not been used for a long time, see page 198 "When Not Using for a Long Period of Time".

# Replacing an Ink Collector Unit

## Checking the Waste Ink Level

Follow the procedure below to check when to replace an ink collector unit using the Status Monitor or the waste ink full indicator.

### Checking the waste ink level on the display

You can check the waste ink level by looking at the icon that appears above the waste ink full indicator.

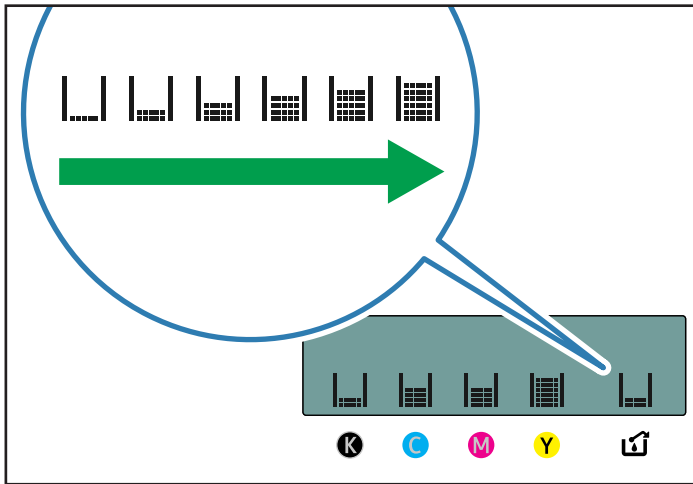

CHU124

If the ink collector unit is almost full, the message "Prepare new Ink Collector Unit" appears on the display.

Make sure you have a new ink collector on hand.

If the ink collector unit is full, the message "Ink Collector Unit is full / Replace Ink Collector Unit" appears on the display.

Replace the ink collector unit.

### Checking the waste ink level on the Status Monitor

The ink collector unit status can be used to check when to replace the ink collector unit.

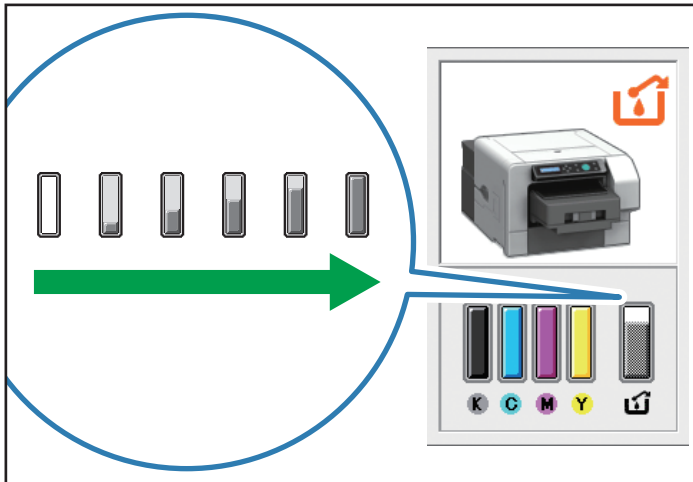

DSA431

1. Open the [Printing Preferences] dialog box.
2. Click the [Maintenance] tab.
3. Click [Display Status Monitor].
4. Check the ink collector unit status.

## Replacing an Ink Collector Unit

### **⚠ WARNING**

- The following explains the warning messages on the plastic bag used in this product's packaging.
  - Keep the polythene materials (bags, gloves, etc.) supplied with this machine away from babies and small children at all times. Suffocation can result if polythene materials are brought into contact with the mouth or nose.

### **⚠ CAUTION**

- Keep ink and ink containers out of reach of children.
- When replacing ink collector unit, avoid getting ink on your clothing. If ink comes into contact with your clothing, wash the stained area with cold water. Hot water will set the ink into the fabric and make removing the stain impossible.
- If ink gets into contact with eyes, wash eyes immediately with running water. Consult a doctor if necessary.

## **⚠ CAUTION**

- When replacing ink, avoid getting ink on your skin. If ink comes into contact with your skin, wash the affected area thoroughly with soap and water.
- When removing the ink collector unit, avoid putting your hand near the place where the ink collector unit is installed. If ink comes in contact with your hands, wash them thoroughly with soap and water.

## **★ Important**

- When removing the ink collector unit, do not touch the inside of the machine.
- Do not use an ink collector unit that has not been used for a long time.
- Do not touch the ink collector unit's chip contacts.
- Take care not to drop the ink collector unit.
- Take care not to drop the ink collector unit when putting it in the supplied plastic bag. The bag might tear, causing ink to spill.
- Make sure the ink collector unit is fully inserted. If it is not, ink will leak inside the machine.

1. Take the ink collector unit out of the box.
2. Open the right front cover.

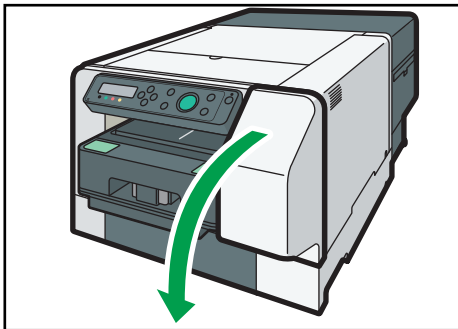

DYX030

3. Wait at least five seconds, and then remove the full ink collector unit from the machine.

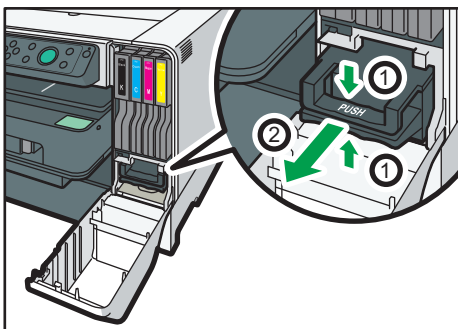

DSA322

While pulling the unit out, keep the unit level and press on the area marked "PUSH".

**4. Put the Ink collector unit in the supplied plastic bag.**

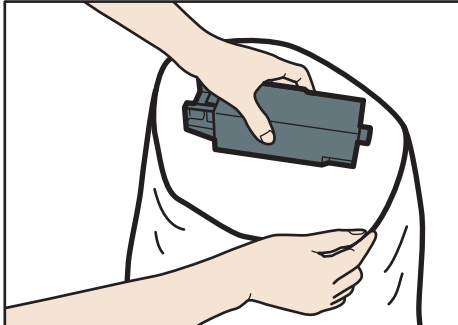

DSA228

**5. Insert the new ink collector unit.**

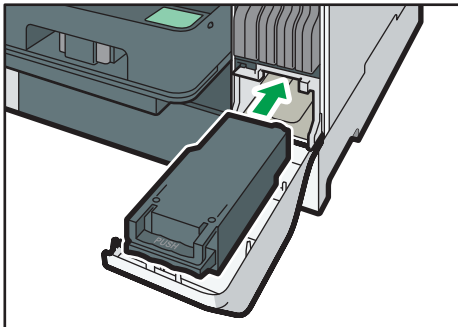

DSA323

**6. Slide the ink collector unit carefully into the machine until you hear it click.**

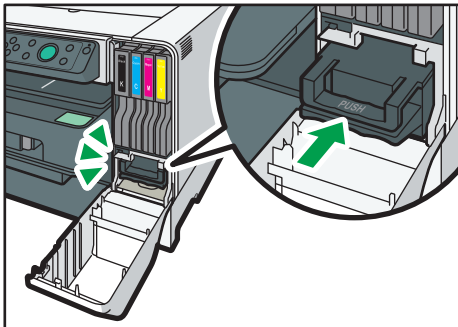

DSA324

**7. Close the right front cover.**

## Replacing Filters

If a message prompting you to replace the filter appears, replace it, and then reset the count for the number of prints using the [Maintenance] menu.

1. Prepare the filter to replace.
2. Pinch the handle of the filter, and then pull it out.

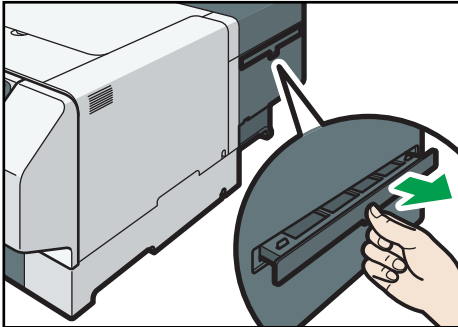

DSB071

3. Insert the new filter firmly.

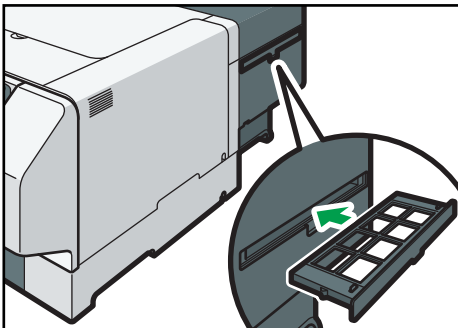

DSB072

4. Replace the filter of the opposite side in the same way.
5. Press the [▼/Menu] key.
6. Press the [▲] or [▼/Menu] key to display [Maintenance], and then press the [#Enter] key.
7. Press the [▲] or [▼/Menu] key to display [Fan Filter], and then press the [#Enter] key.
8. Press the [▲] or [▼/Menu] key to display [Reset count no.], and then press the [#Enter] key.
9. Check that "Press # to reset count no" is displayed, and then press the [#Enter] key.
10. Press the [Escape] key until the top screen appears.

# Adjusting the Fan Speed

You can adjust the fan speed if you are bothered with the fan noise.

1. Press the [▼/Menu] key.
2. Press the [▲] or [▼/Menu] key to display [Maintenance], and then press the [#Enter] key.
3. Press the [▲] or [▼/Menu] key to display [Fan Speed], and then press the [#Enter] key.
4. Press the [▲] or [▼/Menu] key to select the fan speed, and then press the [#Enter] key.

[Normal Speed] is specified as the factory default. Usually, you need not to change the setting.

If you set [Fan Speed] to [Low Speed], the fan becomes quiet and the machine's operational life shortens, depending on the conditions and environment of the machine.

If you set [Fan Speed] to [Off], the fan stops. Note that this might particularly shorten the machine's operational life. Do not use this setting except in special cases.

5. Press the [Escape] key until the top screen appears.

# Cleaning

Clean the outside of the machine regularly to maintain the condition of the machine.

## **WARNING**

- Do not remove any covers or screws other than those explicitly mentioned in this manual. Inside this machine are high voltage components that are an electric shock hazard. Contact your sales or service representative if any of the machine's internal components require maintenance, adjustment, or repair.
- Do not attempt to disassemble or modify this machine. Doing so risks burns and electric shock.

## **CAUTION**

- When performing maintenance on the machine, always disconnect the power cord from the wall outlet.

To clean the exterior of the machine, wipe it with a soft, dry or damp cloth. If the dirt does not come off, wipe the machine first with a cloth moistened with a neutral detergent, then with a damp cloth, and finally with a dry cloth.

## **Important**

- Do not use volatile chemicals like benzene or thinner, or insecticides on the machine. Using these chemicals could deform, crack, or change the color of the machine.
- When wiping the machine with a cloth moistened with detergent, be sure to wipe only the exterior.

---

## Cleaning the Top Cover

---

## **CAUTION**

- Do not open the cover while the machine is operating and keep your hands or fingers clear of the machine. Doing so might cause your hands or fingers to get trapped in the machine, potentially causing injury.



### 1. Open the top cover.

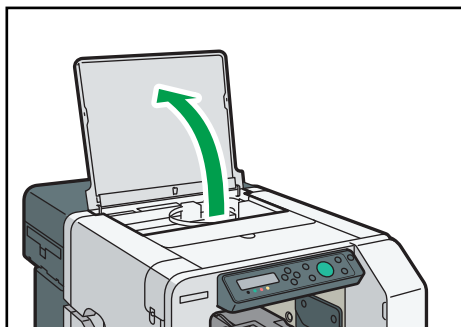

DYX026

2. Wipe the top cover and the area around it by using a cloth moistened with water or cleaning liquid. Unless you can remove the dirt, wipe the machine with a cleaning alcohol (ethanol).

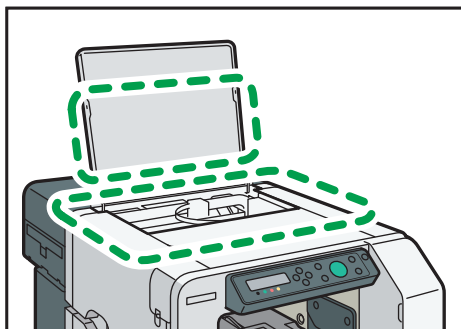

DYX027

### 3. Close the top cover.

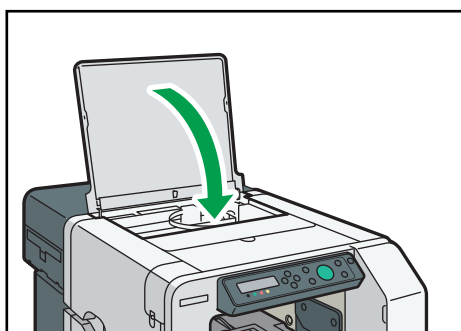

DYX028

## Cleaning the Height Position Sensor

### ★ Important

- Turn off the machine before cleaning the height position sensor.

- When cleaning the inside of the machine, be sure to wear protective glasses and protective gloves.
- Use a cleaning stick and a cleaning liquid or a cleaning alcohol (ethanol) to clean the height position sensor. You can clean it effectively with the corner of a cleaning stick because the lens of the height position sensor is very small and concave.
- To clean the height position sensor, use a new cleaning stick on which there is no any ink or other dirt.

1. Open the top cover.

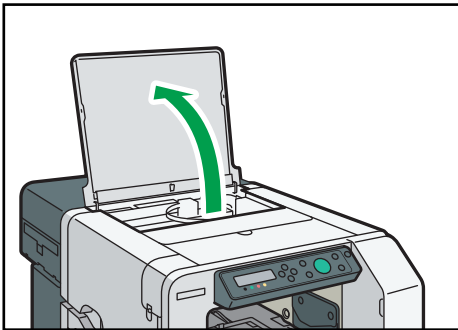

DYX026

- Wipe off dirt on the lens of the height position sensor by moistening the cleaning stick with cleaning liquid or cleaning alcohol (ethanol).

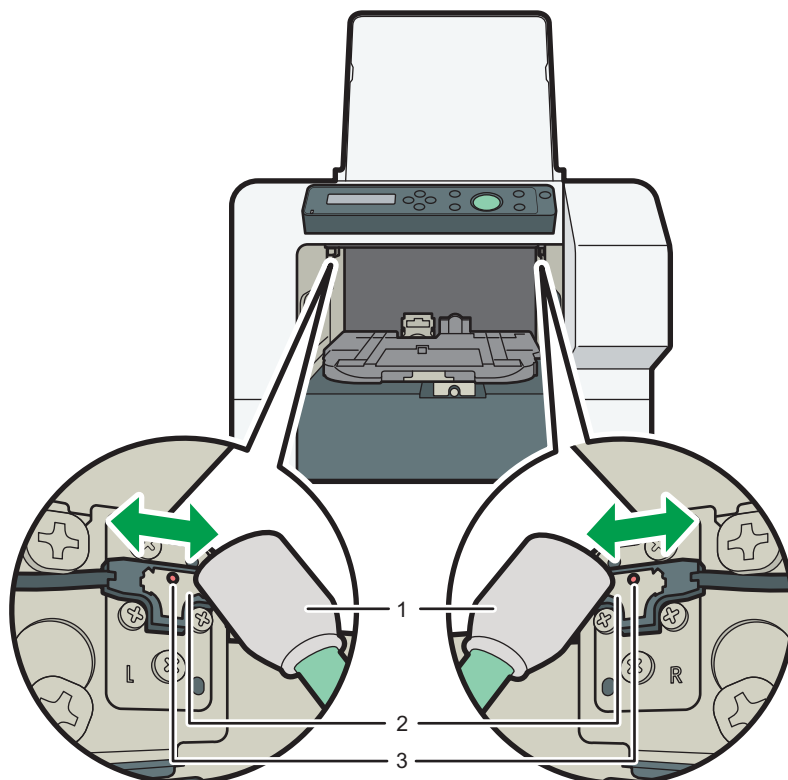

DYX101

- Cleaning stick
- Height position sensor
- Lens

Wipe the area shown in the figure back and forth 10 times. Wait 5 minutes, and then wipe it back and forth 10 times again.

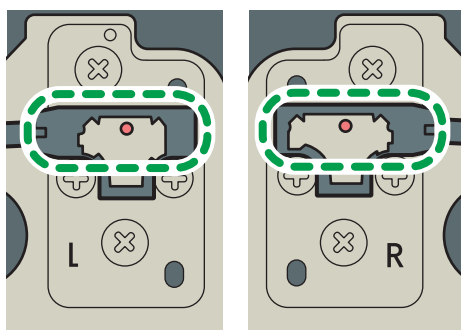

DSB054

**3. Close the top cover.**

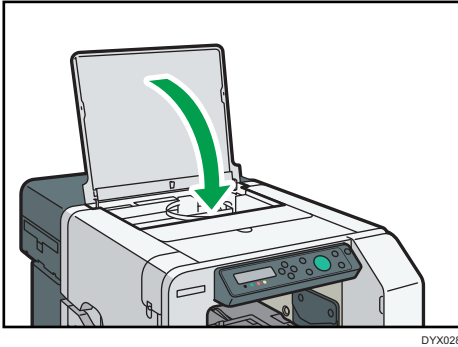

---

## Cleaning the Power Cable Plug

---

This section describes precautions for cleaning the power cable plug.

**⚠ WARNING**

- Be sure to disconnect the plug from the wall outlet at least once a year and check for the following:
  - There are burn marks on the plug.
  - The prongs on the plug are deformed.
- If any of the above conditions exist, do not use the plug and consult your dealer or service representative. Use of the plug could result in fire or electric shock.

- Be sure to disconnect the power cord from the wall outlet at least once a year and check for the following:
  - The power cord's inner wires are exposed, broken, etc.
  - The power cord's coating has a crack or dent.
  - When bending the power cord, the power turns off and on.
  - Part of the power cord becomes hot.
  - The power cord is damaged.
- If any of the above conditions exist, do not use the power cord and consult your dealer or service representative. Use of the power cord could result in fire or electric shock.

**⚠ CAUTION**

- Be sure to disconnect the plug from the wall outlet and clean the prongs and the area around the prongs at least once a year. Allowing dust to build up on the plug constitutes a fire hazard.

# Moving

The precautions when moving the machine a short distance or long distance are explained.

## Moving a Short Distance

Take the following precautions when moving the machine a short distance - for instance, when relocating the machine inside the same room.

### CAUTION

- The printer weighs around 24 kg (53.0 lb).
  - Hold the lift indentations at the base of the machine's sides with two people or more. Lift it slowly and do not strain your body.
  - When moving the machine, be sure to remove the tray and manual pocket. Lifting the machine forcefully or treating it roughly may break it or result in injury.
- Unplug the power cord from the wall outlet before you move the machine. While moving the machine, take care that the power cord is not damaged under the machine. Failing to take these precautions could result in fire or electric shock.
- When disconnecting the power cord from the wall outlet, always pull the plug, not the cord. Pulling the cord can damage the power cord. Use of damaged power cords could result in fire or electric shock.

### Important

- **Be sure to keep the machine level. If it is unduly tilted, ink will leak from the ink collector.**
1. Press and hold down the [Power] key until it turns off, and then unplug the power cord.
  2. Disconnect the USB cable or Ethernet cable.
  3. Remove the tray and manual pocket.

**4. Lift the machine and move it to the place where you want to install it.**

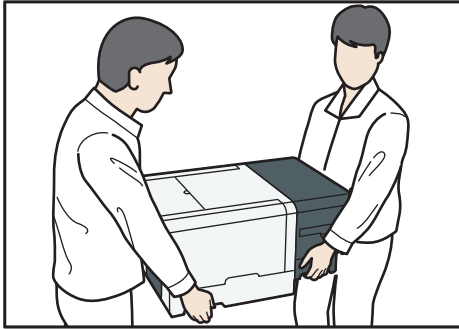

DSB067

Grip the indentations for lifting at the base of the machine's sides with two people or more, as shown. Lift and carry the machine slowly and carefully.

**↓ Note**

- When you move the machine, unplug the power cord from the machine, too.
- Make sure the power cord is not trapped under the machine.

---

## Moving a Long Distance

---

To transport the machine, put it in the box it came in.

For details, contact your sales or service representative.

**★ Important**

- Check the type of ink cartridges that are installed in the machine before moving the machine.
- If M-size cartridges (RICOH Garment Ink Cartridge XX Type 1) are installed, do not remove them. Make sure that the ink cartridges have been fully pushed in, and then move the machine.
- If L-size cartridges (RICOH Garment Ink Cartridge XX (Hi Yield) Type 1) are installed, remove the ink cartridges before moving the machine. However, if you store the machine after moving it, be sure to install the ink cartridges again before storing the machine. When installing the ink cartridges, make sure that they have been fully pushed in.
- Remove the tray.

**↓ Note**

- The inside of the machine may become dirty if the machine is not level when transported.
- When you move the machine, also unplug the power cord from the machine.

# Disposing

To dispose of this machine, consult with an authorized dealer.

When disposing of the machine by yourself, be sure to comply with local disposal regulations.

## When Not Using for a Long Period of Time

If you do not use the machine for a long time, ensure the following:

- Clean the internal compartments using the dedicated cleaning cartridge in advance. For the cleaning method, see page 133 "Clean Internals".
- Once the internal compartments are cleaned, turn the machine power off, disconnect the USB cable or Ethernet cable, and then unplug it from the wall outlet.

It is recommended to print at least once a month, because the machine consumes a considerable amount of ink for periodic maintenance and print head cleaning when turned on after a long period of inactivity.

### CAUTION

- If this machine is not going to be used for several days or longer at a time, disconnect its power cord from the wall outlet.
- When disconnecting the power cord from the wall outlet, always pull the plug, not the cord. Pulling the cord can damage the power cord. Use of damaged power cords could result in fire or electric shock.

Be careful of the following:

- The nozzles of the print heads may dry out and become clogged. To prevent this, periodically print something. Even if you do not print anything, turn the machine on for a few minutes once every 20-25 days.
- If you do not use the machine for a long period of time, always check if the nozzles are clogged by printing a nozzle check test pattern. See page 114 "Nozzle Check". Clean the print heads as necessary, and then begin printing. See page 116 "Head-cleaning".
- If you try to use the machine after it has been out of use for a long time, it may not print properly even if head cleaning is carried out several times. If this is the case, carry out head flushing. See page 118 "Head-flushing". If the print heads are still clogged, leave the machine for about ten minutes, and then print the nozzle check pattern. If the problem persists, turn the machine off and leave it for at least eight hours. This should unplug the print heads.

### Note

- After head cleaning is performed multiple times, clogged ink will dissolve over time, and normal printing may become possible.
- If there is no improvement after performing the steps above, contact sales or service representative.



# 9. Troubleshooting

---

This chapter describes troubleshooting procedures that are applicable to all functions of this machine and what to do when print results are not satisfactory or error messages appear on the display.

## Software Cannot Be Installed

This section explains how to troubleshoot software installation problems under different environments.

---

### Confirming Installation

---

Check whether the software has been installed.

#### Checking icons

If the printer driver is properly installed, the machine icon appears in the [Devices and Printers] window. If the icon does not appear, the software has not been installed. Try installing the software again. See page 42 "Connecting the Computer and Installing the Printer Driver".

#### Checking ports

In the [Printer Properties] dialog box, check that USB connection or network printer is selected for the port. To check the connection, perform a test print. If the test print is not printed, see page 202 "If Test Print Fails".

---

### Checking Your Computer Environment

---

Check the system requirements for installing the software.

#### Quick Install for USB

---

##### The CD-ROM may not be inserted properly.

Check that the CD-ROM is inserted properly. Check also that it is not damaged and the CD-ROM drive is working properly.

##### The power cord or USB cable may not be properly connected.

Check that the power cord and USB cable are properly connected and not damaged.

##### The operating system is incompatible.

##### There is insufficient hard disk space.

Check that the computer's operating system is fully compatible with this machine. See page 28 "Checking the Computer and Installation Area".

**Other applications are not closed.**

When installing software, quit all other applications. Installation may be disrupted if other applications are open. Also, quit any anti-virus applications that are running.

**The machine is turned on before installation.**

Turn the machine off and then on, and then try "Quick Install for USB" again.

**The USB connection does not work.**

Turn the machine off, unplug the USB cable from the machine, launch "Quick Install for USB" again, and then turn the machine on when the dialog box confirming printer driver installation appears. If this does not resolve the problem, press the [▼/Menu] key, change [USB Setting] in [Host Interface] from [Auto] to [Full Speed], uninstall the printer driver, delete the device, and then launch "Quick Install for USB" again.

**Windows made USB settings automatically.**

Open Windows' Device Manager, and then, under [Universal Serial Bus controllers], remove any conflicting devices. Conflicting devices will be indicated by a yellow [!] or [?] icon. Take care not to accidentally remove required devices. For details, see page 204 "Deleting Devices".

**An error occurs during the installation because the machine is recognized as an unidentified device.**

Follow the troubleshooting procedure described under in "The USB connection does not work" or "Windows made USB settings automatically" section.

## Quick Install for Network

---

**The CD-ROM may not be inserted properly.**

Check that the CD-ROM is inserted properly. Check also that it is not damaged and the CD-ROM drive is working properly.

**The power cord or Ethernet cable may not be properly connected.**

Check that the power cord and Ethernet cable are properly connected and not damaged.

**The operating system is incompatible.**

**There is insufficient hard disk space.**

Check that the computer's operating system is fully compatible with this machine. See page 28 "Checking the Computer and Installation Area".

**Other applications are not closed.**

When installing software, quit all other applications. Installation may be disrupted if other applications are open. Also, quit any anti-virus applications that are running.

**The machine's IP address has not been specified.**

### **The computer and printer are not on the same network segment.**

If the printer cannot be found and only "Printer Port" appears in the [Printer Selection] dialog box, either the machine's IP address is not specified or the computer and printer are not on the same network segment. Before installing the software, check the machine's IP address and the network environment. Alternatively, select "Printer Port" in the dialog box, and then install the printer driver.

---

## **Printer Driver Cannot Be Installed**

---

This section explains how to troubleshoot printer driver installation problems.

### **The printer driver installer does not start.**

#### **An error occurs during installation.**

- If the screen does not appear even when you double-click the [SETUP.EXE] icon, or if an error occurs during installation, access the CD-ROM drive from [Computer (or My Computer)] or [Explorer]. Double-click the [RP\_SETUPXX.EXE] icon, and then install the printer driver by following the instructions that appear on the screen.
- An error occurs if the path to the location of the stored data is too long. To install a printer driver downloaded from a Web site or copied from a CD-ROM, save the printer driver directly on the hard disk, and then install it.
- Add the printer without using the installer.

On the [Start] menu, click [Devices and Printers], click [Add a printer], and then install the printer driver according to the displayed instructions.

- For Windows 10: Click [Control Panel], [Hardware and Sound], [Devices and Printers], and then click [Add a printer].

For details about adding printers, see the Windows Help.

---

## **USB Connection is not Automatically Detected**

---

If the USB connection is not automatically detected, do the following procedure:

### **1. Delete the printer driver.**

See page 203 "Uninstalling the Printer Driver".

### **2. Delete the device.**

See page 204 "Deleting Devices".

### **3. Run [Quick Install for USB] again.**

See page 45 "Quick Install for USB".

If these steps do not resolve the problem, contact your sales or service representative.

# If Test Print Fails

This section explains how to troubleshoot Test Print problems.

## **The power cord or USB cable or Ethernet cable is not properly connected.**

Check that the power cord and USB cable, Ethernet cable are properly connected.

## **The port connection is not properly set.**

This guide uses Windows 7/10 procedures for its examples. Procedures and screens might vary depending on the operating system you are using.

1. On the [Start] menu, click [Devices and Printers].
  - For Windows 10: Click [Control Panel], and then click [View devices and printers].
2. Right-click the machine icon, and then click [Printer properties].
3. Click the [Ports] tab, and then check the printer port.

Select USB or network printer in the list when the selected port connection is something other than USB or network printer.

To connect via USB when USB does not appear in the list, you must re-install the printer driver. See page 201 "USB Connection is not Automatically Detected".

## **Ink feed is incomplete.**

Ink begins automatically feeding into the print heads when the power of the machine is first turned on or when a cartridge is replaced.

Wait until ink feed is complete at which point the power lamp stops flashing and remains lit.

## **A printer error has occurred.**

Check the error message on the display, resolve the problem, and then perform the test print again.

See page 223 "Error & Status Messages on the Display".

If you cannot resolve the problem, contact sales or service representative.

### **Note**

- If the Status Monitor displays an error message, see page 229 "Status Monitor Errors".

# Uninstalling

If software was installed incorrectly or incompletely, uninstall and then re-install it.

This guide uses Windows 7/10 procedures for its examples. Procedures and screens might vary depending on the operating system you are using.

## ★ Important

- **Before uninstalling software or deleting devices, turn off any other printers connected to your computer via USB, or disconnect the USB cable to the printers.**

## ↓ Note

- Screens vary according to the operating environment.
- To re-install the software, restart Windows.

---

## Uninstalling the Printer Driver

---

## ★ Important

- **The Status Monitor installed with the current printer driver is uninstalled when the current printer driver is uninstalled.**

1. Press and hold down the [Power] key for one second.
2. On the [Start] menu, click [Devices and Printers].
  - For Windows 10: Right-click [Start], click [Control Panel], and then click [View devices and printers].
3. Right-click the machine icon, and then click [Remove device].
4. Click [Yes].

The printer driver is uninstalled.
5. Select an arbitrary printer, and then click [Print server properties].
6. Click the [Drivers] tab.
7. In the [Installed printer drivers:] list, select [Printer Name], and then click [Remove].
8. Click [Remove driver and driver package], and then click [OK].
9. Click [Yes].
10. Click [Delete].
11. Click [OK].
12. Click [Close].
13. Restart Windows.

**Note**

- To update the printer driver, download the latest driver from the manufacturer's Web site.

---

## Deleting Devices

---

If Windows automatically establishes a USB connection because of an unauthorized device, you can delete the device and any others like it. Be sure not to delete necessary devices. If USB connection is established normally, you do not need to perform this procedure.

1. Turn the machine on.
2. On the [Start] menu, click [Control Panel].
  - For Windows 10: Right-click [Start], and then click [Control Panel].
3. Click [System and Security].
4. Click [Device Manager] in [System].
5. Click [USB Printing Support] or [Product Name].
6. Click [Action], and then click [Uninstall].
7. Click [OK].
8. Click [Close].

# Printing Does Not Start

If printing fails, check the following:

## Check the machine's power.

- The power lamp is not lit.

Turn the machine on.

See page 24 "Turning On/Off the Power".

- The power lamp does not light up or flash despite the [Power] key being pressed.

Check whether the power cord is plugged into the receptacle properly.

Plug another appliance that works into the receptacle to determine whether the receptacle is all right.

If the problem persists, unplug the power cord and contact your sales or service representative.

## Check the error message.

- If the error message appears on the display

See page 223 "Error & Status Messages on the Display".

- If the error message appears on the Status Monitor

See page 229 "Status Monitor Errors".

## Check the name associated with the printer's icon.

If you share the printer, make sure the name associated with the printer's icon does not exceed 32 characters.

## Check the printer driver setting.

On the [Detailed Settings] tab, select [Print Quality], and then select the [Change Data Processing] check box.

## Checking the Version of the Printer Driver

If it is not the latest version, update the driver.

- Checking the version of the printer driver on a Windows
  1. Open the [Printing Preferences] dialog box from the application.
  2. On the [Configuration/About] tab, click [About].
  3. Check the version.
- Checking the version of the printer driver on a Macintosh
  1. On the [Apple] menu, click [System Preferences...].
  2. Click the [Printers & Scanners].
  3. Select the printer you want to use from the printer list, and then click [Options & Supplies...].

4. On the [General] tab, check the displayed version number.

- Use the Internet to find the latest version of the driver.

See manufacturer's Web site for the latest driver.

- Update the printer driver.

If you are using Windows, install the downloaded driver and check [Update the current printer driver] in the dialog box that allows you to select what to install.

If you are using a Macintosh, uninstall the current printer driver before installing the new one.

### **Check the connection status of the Wireless LAN**

- Check the settings of Network and Wireless LAN under the Interface menu.

[▼/Menu] key > [Host Interface] > [Network Setup]

[▼/Menu] key > [Host Interface] > [Wireless LAN]

See page 53 "Connecting the Machine via a Wireless LAN Interface".

- Check the installation status.

Check that there are no obstacles between the wireless router (access point) and the machine, or between the tablet device or computer and the wireless router (access point).

Position the wireless router (access point) and the machine away from devices which emit electric waves such as microwave ovens.



# The Tray Does Not Operate Correctly

This section explains how to troubleshoot when printing does not start even though the tray is loaded, when the tray cannot be removed or the fabric or a foreign object is stuck.

## Checking the Status of the Fabric and the Tray

If printing does not start with an error message even after the tray is loaded, check the following:

### The fabric is incorrectly loaded

#### **Wrinkles, slacks or floats remain on the printing surface.**

Load the fabric while smoothing out the fabric from the center outward so that the printing surface becomes flat.

See page 72 "Loading Fabrics".

#### **Removal of dust/flattening fibers is not performed or performed insufficiently.**

Before printing, straighten out the fabric. Once dust is removed from the printing surface of the fabric, flatten the fabric and remove wrinkles.

See page 87 "Removing Dust and Flattening Fibers".

#### **The edges of the fabric are protruding from the tray.**

The edges of the fabric are protruding from the tray. Tuck under the table the parts protruding from the table of the tray.

See page 72 "Loading Fabrics".

#### **A non-compatible fabric is loaded.**

Remove the loaded fabric and load a usable fabric.

See page 70 "Usable Fabric".

#### **Uneven fabric is loaded.**

With uneven fabric, the height of the tray may not be correctly detected. Adjust the height of the tray.

See page 208 "Adjusting the Height of the Tray".

#### **Wrinkly fabric is loaded.**

When printing on wrinkly fabric while [Select Print Quality:] is set to [Vivid] and [Garment Type:] is set to [T-shirt (White/Pale)] in the printer driver, a height position sensor in the machine may react. If this is the case, set [Select Print Quality:] to [Fine].

See page 98 "Printing".

## The tray is incorrectly loaded

---

### **The tray is not pushed to the back.**

Place the rear side of the tray on the tray stand, and then slowly push it in all the way until it clicks.

See page 72 "Loading Fabrics".

### **The position of the tray is too high.**

A height position sensor in the machine is reacting. Remove the tray and reload the fabric correctly, and then reload the tray. If printing does not start, adjust the height of the tray.

See page 72 "Loading Fabrics", page 208 "Adjusting the Height of the Tray".

## Foreign objects remain inside the machine

---

Remove the tray and find foreign objects inside the machine.

## Adjusting the Height of the Tray

---

When you have multiple trays, the appropriate height for printing with each tray varies depending on the type of the tray and the garment to be loaded on it. Therefore you need to adjust the height of the tray before you start printing. If you set the height value in the [Maintenance] menu before printing, the machine adjusts the height of the tray to that height value when printing starts. If you adjust the height of the tray after sending a print job, use the [Adjust Height ▼] key. This section explains how to adjust the height of the tray using the [Adjust Height ▼] key to resolve the problem caused by the height position sensor reacting after the machine starts printing. For details about adjusting the height of the tray using the [Maintenance] menu to improve the image quality, see page 209 "Adjusting the height of the tray automatically" or page 210 "Adjusting the height of the tray manually".

If wrinkles, slacks, or floats remain on the fabric or dust or similar objects are attached, the height position sensor reacts and printing may not start. If this is the case, remove the tray and reload the fabric correctly, and then reload the tray.

See page 72 "Loading Fabrics".

If an error message appears even after the tray is loaded and printing does not start, adjust the height of the tray as follows:

### **1. Press the [Adjust Height ▼] key to lower the tray.**

If a height detection error occurs, press the [Adjust Height ▼] key to lower the tray. You can adjust the height in increments of 0.1 mm (0.01 inches). Look inside the machine as you lower the tray so that you can see the position at which the sensor is not obstructed.

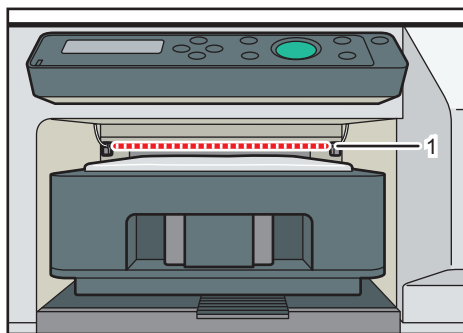

1. Sensor
2. Press the [Start] key.

Printing starts.

If printing does not start, repeat Steps 1 and 2 until the height becomes appropriate for printing.

## Adjusting the height of the tray automatically

### ★ Important

- Remove the garment from the tray before performing auto adjustment. Do not perform auto adjustment while the garment is on the tray.
- When you perform auto adjustment, the height of the tray is adjusted appropriately according to the tray that is set. Perform auto adjustment again every time a different tray is set.
- When you perform auto adjustment, the height of the tray is adjusted so it is suitable for loading thin garments, such as T-shirts. When loading thick garments in the tray, finetune the height of the tray using the [Adjust Height ▼] key after sending the print job. For details, see page 208 "Adjusting the Height of the Tray".

When printing starts, the machine adjusts the height of the tray according to the height value specified in the [Maintenance] menu. If the printed image is blurry or there is dust stuck to it, or the height of the tray may not be adjusted appropriately, adjust the height of the tray using the [Maintenance] menu. This section explains how to adjust the height of the tray automatically using the [Maintenance] menu. For details about adjust the height of the tray manually using the [Maintenance] menu, see page 210 "Adjusting the height of the tray manually".

1. Load the tray without a garment on it.
2. Press the [▼/Menu] key.
3. Press the [▲] or [▼/Menu] key to display [Maintenance], and then press the [#Enter] key.
4. Press the [▲] or [▼/Menu] key to display [Height Adjust], and then press the [#Enter] key.
5. Press the [▲] or [▼/Menu] key to display [Auto Adjust], and then press the [#Enter] key.

### 6. Check that "Press # to start" is displayed, and then press the [#Enter] key.

Auto adjustment starts after the tray is loaded into the machine. After auto adjustment is completed, the tray returns and stops in position so that you can see the tray positioning line on the left side of it.

#### ↓ Note

- The value set by adjustment is stored in [Manual Adjust] in the [Maintenance] menu.
- If an error occurs during auto adjustment, perform the operation from Step 1 again.

## Adjusting the height of the tray manually

#### ★ Important

- If you enter a negative value as the height value, the height position sensor in the machine may react. Load the fabric correctly so that the printing surface can be flat.
- If the fabric is not correctly set after the height of the tray is adjusted manually, the machine might not start printing because a height position sensor in the machine reacts when you send a print job. In this case, remove the tray, load the fabric into the tray correctly, and then load the tray into the machine.
- The image quality might deteriorate if you change the height value significantly. In this case, adjust the registration.
- Adjust the height little by little so that the print side is not rubbed.

When printing starts, the machine adjusts the height of the tray according to the height value specified in the [Maintenance] menu. If the printed image is blurry or there is dust stuck to it, or the height of the tray may not be adjusted appropriately, adjust the height of the tray manually using the [Maintenance] menu.

If the distance between the print head and the fabric is too large, the printed image might be blurry. If this is the case, enter a negative value as the height value.

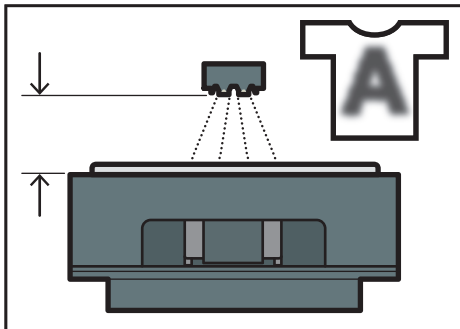

DSA214

If the distance between the print head and the fabric is too small, dust might stick to the fabric. If this is the case, clean both the Maintenance Unit and print head. If the problem is not resolved, enter a positive value as the height value.

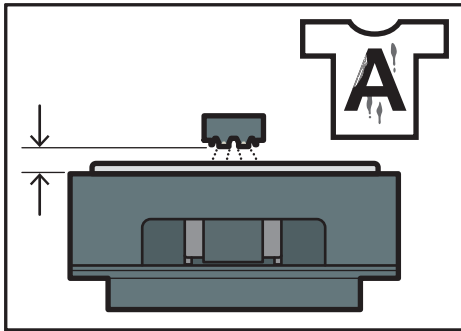

DSA215

When the distance between the print head and the fabric is suitable, the printed image is satisfactory as shown in the figure.

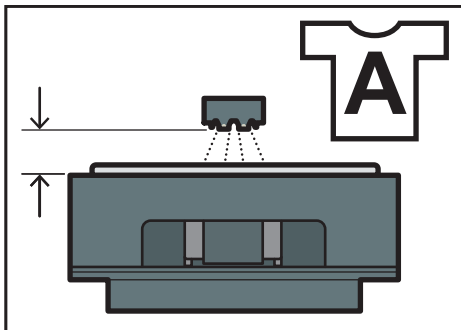

DSA216

1. Press the [▼/Menu] key.
2. Press the [▲] or [▼/Menu] key to display [Maintenance], and then press the [#Enter] key.
3. Press the [▲] or [▼/Menu] key to display [Height Adjust], and then press the [#Enter] key.
4. Press the [▲] or [▼/Menu] key to display [Manual Adjust], and then press the [#Enter] key.
5. Press the [▲] or [▼/Menu] key to enter the height value, and then press the [#Enter] key.
  - You can enter a height value from -20 to 20 in increments of 0.1. We recommend changing the existing setting by entering values in increments of  $\pm 0.1$  to 0.3.
  - If the printed image is blurry when the A4 standard tray or A5 tray is used, first enter "-2.0" as the height value, and then increase the value in increments of 0.1 to 0.3 until the error message is not displayed. While adjusting the height, load the fabric into the tray so that the printing surface can be flat.
  - If you enter a negative value as the height value and the value is too small, the machine might not start printing because the height position sensor in the machine reacts. Adjust the height of the tray by pressing the [Adjust Height ▲] or the [Adjust Height ▼] key.

#### ↓ Note

- The value you set in Step 5 remains after the machine is turned off.

- If you enter "-2.0" as the height value and want to increase the value in Step 5, press the [Stop] key to cancel printing whenever you enter a new height value.

---

## Removing the Tray Manually

---

If the tray is not automatically ejected, eject the tray using any of the following procedures:

### Turning the power back on

---

Turn the power off, and then turn the power on again. The tray stand moves to the front and the tray will be ejected.

### Pressing the [Tray] key

---

If the tray is not ejected even if the power is turned on again, press the [Tray] key and move the tray stand to the front.

If the tray is not removed using above mentioned procedures, a fabric or foreign object may be stuck inside the machine. Open the top cover and remove the fabric or foreign object, and then remove the tray.

See page 212 "Removing a Fabric or Foreign Object by Opening the Top Cover".

---

## Removing a Fabric or Foreign Object by Opening the Top Cover

---

### CAUTION

- Do not open the cover while the machine is operating and keep your hands or fingers clear of the machine. Doing so might cause your hands or fingers to get trapped in the machine, potentially causing injury.

### Important

- Normally, keep the top cover closed. For safety reasons, opening or closing the top cover will cause the power to turn off immediately. Do not open or close the top cover when not required, such as while printing is performed. When a message prompting you to open the top cover appears on the display, follow the instructions.
- Do not touch the ink tubes or toothed rubber belt. Also, take care not to catch cables or ink tubes with your sleeves.

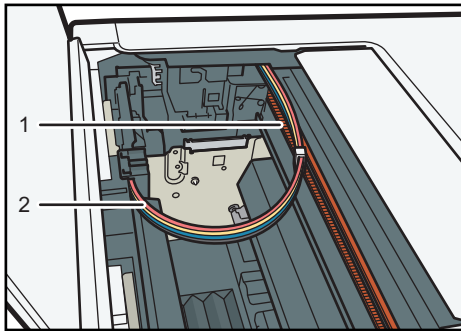

**1. Toothed rubber belt**

**2. Ink tubes**

**1. Open the top cover.**

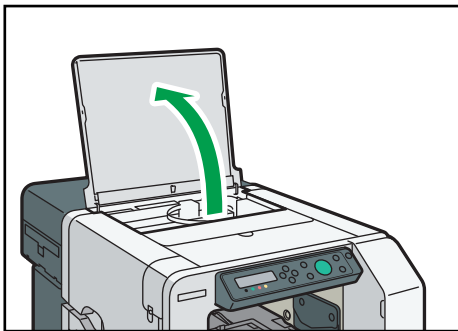

**2. Press the [Tray] key.**

**3. Remove the stuck fabric or foreign object through the top cover opening.**

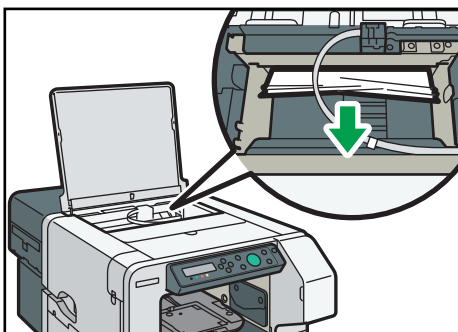

Remove the fabric or foreign object carefully. Forcibly removing them may cause parts to come off.

If the print head has stopped halfway, move it to either end.

**4. Close the top cover.**

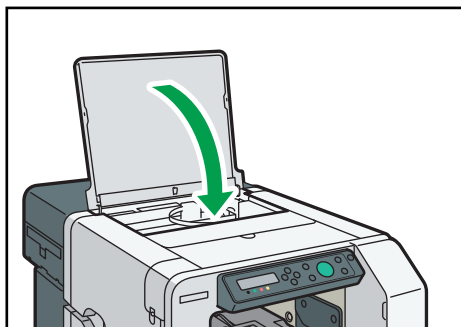

DYX028

The power of the machine turns off and on automatically, after which it returns to the usual condition.

**5. Print the nozzle check test pattern to make sure the print head's nozzles are not clogged.**

See page 114 "Nozzle Check".

**Note**

- If a fabric or foreign object cannot be successfully removed, perform [Move Print-Heads], and then remove the fabric or foreign object. See page 127 "Move Print-Heads".



# Print Results Are Not Satisfactory

If print quality is poor, check the machine and printer driver settings for problems. If no problems are apparent, check the ink cartridge or other consumables. For details about handling fabric, see page 70 "Fabric". For details about handling the ink cartridges, see page 182 "Handling Ink Cartridges".

## ↓ Note

- If problems persist even after configuration checks indicate correct values, contact your sales or service representative.

## Prints are Unsatisfactory

This section explains how to troubleshoot the machine when printing is uneven (due to the wrong amount of ink being used) or when prints are smudged, smeared, or blotchy or when the color of the print differs from the previous one.

### Have you printed the nozzle check test pattern?

Print the nozzle check test pattern to check whether the print head nozzles are all ejecting ink properly, and, if necessary, carry out head cleaning or head-flushing.

1. Execute Nozzle Check to determine the number of the clogged print head.
2. Perform Head Cleaning for the clogged print head.
3. Execute Nozzle Check to determine whether the problem has been eliminated.
4. If the problem persists, do not use the machine for 5 to 10 minutes.

By doing this, minute bubbles in the print head nozzle may disappear as the air in them dissolves into the ink, resulting in unclogging.

5. Execute Nozzle Check to determine whether the problem has been eliminated.

If the problem persists, repeat Steps 1 to 5 a few more times.

Also letting the machine stand idle after repeating the procedure may help eliminate the clogging.

If the problem persists, perform Steps 1 to 5 again, but instead of performing "Head-cleaning" in Step 2, perform "Head-flushing".

Head Flushing, which cleans the print head more thoroughly than Head Cleaning, consumes a lot of ink. See page 114 "Nozzle Check", page 116 "Head-cleaning" and page 118 "Head-flushing".

### Has the machine not been used for a long time?

The ink may be dry or the nozzles of the print heads may be clogged. Print the nozzle check test pattern and clean the print heads as necessary.

See page 114 "Nozzle Check", page 116 "Head-cleaning".

**Have the print heads been aligned?**

Blurred or double lines indicate the print heads are incorrectly positioned. Resolve this by selecting [Head Position]. If the problem persists, print the nozzle check test pattern and clean the print heads as necessary.

See page 119 "Head Position", page 114 "Nozzle Check" and page 116 "Head-cleaning".

**Is there a problem with the machine's location?**

Make sure that the machine is level. Place the machine in a location where it will not be subject to shaking or excessive force.

See page 28 "Checking the Computer and Installation Area".

**Have you performed registration?**

Perform registration if the print start point indicates misalignment.

See page 122 "Registration".

**Does the fabric (garment) type setting match?**

Make sure that the fabric (garment) type setting of the Design Software or the printer driver matches the type of fabric (garment) loaded.

See page 98 "Printing".

**Is the fabric being used too thick or thin?**

Check if the fabric is compatible. The print heads will rub against fabric that is too thick or thin, and this will cause smearing.

See page 70 "Usable Fabric".

**Uneven fabric, fluffy fabric, or wrinkled fabric is loaded.**

With uneven fabric, fluffy fabric, or wrinkled fabric, the height of the tray may not be appropriately adjusted. Adjust the height of the tray manually.

See page 210 "Adjusting the height of the tray manually".

**Have you touched the printed side of the fabric?**

Avoid touching the printed side of the fabric. When using the A4 standard tray or A5 tray, load the protection cover, and then remove it with the A4 standard tray or A5 tray. This prevents you from coming into contact with the printing surface.

See page 70 "Precautions Regarding Fabric".

**Is the printing surface of the fabric flat?**

If wrinkles, slacks or floats remain on the printing surface of the fabric, position aberration or blurring may occur in the image. Load the fabric while smoothing out the fabric from the center onward so that the printing surface becomes flat.

### Is the fabric loaded in the correct orientation?

The print direction varies depending on the application you use. Make sure that the orientation of the image to be printed matches the orientation of the fabric loaded in the tray.

See page 72 "Loading Fabrics".

### Is the temperature setting appropriate for the optional finisher that is working to fix the ink to the fabric?

If the fabric's color changes, lower the temperature and adjust it for the fabric. If this does not resolve the problem, attach the spacer to the inside of the tray.

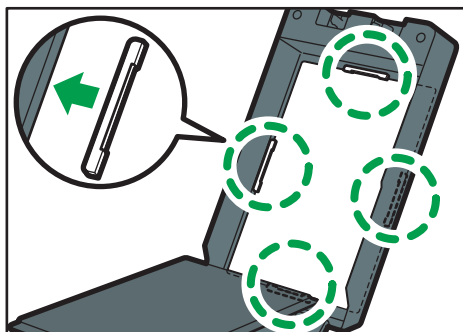

DSA545

### Are the heater and fabric in contact?

If the fabric becomes dirty, attach the spacer to the inside of the tray.

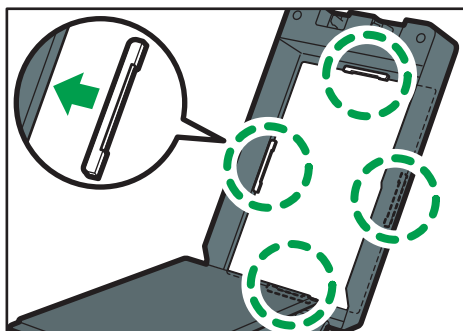

DSA545

#### ↓ Note

- As the spacer is needed to operate the finisher, keep it in a safe place.
- Before attaching the spacers, make sure that the tray is sufficiently cool. Before removing the spacers, make sure that the tray and spacers are sufficiently cool.
- If the fabric's color does not change or the fabric does not become dirty, remove the spacers and use just the tray.

### **Is the temperature of the machine too high?**

If the machine's temperature is too high, the density of prints might become uneven.

- Do not expose the machine to direct sunlight.
- Keep the machine away from objects that may become hot.
- Do not print or use the finisher continuously if the temperature of the area in which the machine is located is 30°C or higher.
- If the density of prints is uneven, even though the above conditions do not apply, wait until the machine cools off. The machine may require an hour or so to cool.

### **Do you perform regular maintenance?**

If the Maintenance Unit and print head nozzles are not cleaned regularly, normal printing results may not be achieved.

If the message prompting you to provide regular maintenance appears, clean both the Maintenance Unit and print head. Even if the message does not appear, performing regular maintenance may resolve image quality problems.

See page 129 "Clean Maint Unit", page 132 "Auto Head Maint."

### **Have you changed the settings in the printer driver?**

When you change the setting for [Select Print Quality:] or [Garment Type:] in the printer driver, you might need to adjust the height of the tray on the machine.

See page 98 "Printing", page 210 "Adjusting the height of the tray manually".

### **Have you adjusted the height of the tray?**

When printing starts, the machine adjusts the height of the tray according to the height value specified in the [Maintenance] menu. If the printed image is blurry or dusty, adjust the height of the tray using the [Maintenance] menu. Printed images may be blurry, especially, when you load a T-shirt and set [Select Print Quality:] to [Vivid] in the printer driver. If this is the case, set [Select Print Quality:] to [Fine] in the printer driver or make the distance between the print head and the garment smaller by adjusting the height of the tray. However, the print quality might deteriorate when setting [Select Print Quality:] to [Fine] as compared with setting [Select Print Quality:] to [Vivid]. Also, note that when making the distance between the print head and the garment smaller, a height detection error might occur. If a height detection error occurs, remove the tray, load the garment correctly into the tray, and then load the tray into the machine.

See page 210 "Adjusting the height of the tray manually", page page 89 "Printing", and page 209 "Adjusting the height of the tray automatically".

---

## **Colors Do Not Match the Displayed Image**

---

If there are differences between colors of the print results and the displayed image, refer to the following questions:

**Has the hue of colors been adjusted?**

Since printed colors and screen colors are produced by different methods, a color printed and a color displayed on a screen can have different hues even though they are the "same" color. Use the color matching function to make the hue of printed colors and displayed colors closer.

For details about the color matching function, see the printer driver Help.

**Has the nozzle check been performed?**

The print heads may be clogged and the amount of ink may not be able to be regulated. Print the nozzle check test pattern and clean the print heads as necessary.

See page 114 "Nozzle Check", page 116 "Head-cleaning".

**Was printing done in black and white?**

Check the color setting of the application and the color print setting of the printer driver.

**Have the print quality settings been made?**

In the [Select Print Quality:], select [Fine], [Speed], or [Vivid] (only for thin fabrics).

**Does the fabric (garment) type setting match?**

Make sure that the fabric (garment) type setting of the Design Software or the printer driver matches the type of fabric (garment) loaded.

See page 98 "Printing".

---

## Positions Do Not Match the Displayed Image

---

If the position of printed items differs from the position of displayed items, refer to the following questions:

**Have the settings for page layout been made?**

Check whether page layout settings have been made with the application.

**Does the tray size setting match?**

Make sure that the tray size selected in the [Print On:] list of the [Printing Preferences] dialog box matches the size of the tray loaded.

**Have the print heads been aligned?**

When bidirectional printing is performed, select [Head Position] to align the print heads. If the problem persists, print the nozzle check test pattern and clean the print heads as necessary.

See page 119 "Head Position", page 114 "Nozzle Check" and page 116 "Head-cleaning".

**Is the fabric correctly loaded?**

Put marks for positioning using the supplied protection cover, and then load the fabric so that the marks match the corners of the table.

See page 72 "Loading Fabrics".

### **Have you changed print quality?**

When printing on fabrics of varied thicknesses or you are concerned with position aberration or image blurring, try unidirectional printing to improve print quality.

In [Print Quality] on the [Detailed Settings] tab, select the [Uni-directional print only] check box. Note, however, that this will slow printing down.

---

## **Other Problems**

---

You may eliminate certain problems by changing the printer driver settings as described below:

### **Cannot print certain data properly when using a certain application, or cannot print image data properly.**

- In the [Select Print Quality:], select [Vivid]. If [Vivid] cannot be selected, select [Fine].
- On the [Detailed Settings] tab, select [Driver Options], and then select the [Spool Data in EMF Format] check box.
- On the [Detailed Settings] tab, select [Print Quality], and then clear the [Adjust Photographs] and [Smooth Low Resolution Images] check boxes.
- On the [Detailed Settings] tab, select [Print Quality], and then select the [Change Data Processing] check box.

### **Some characters are garbled or missing.**

- On the [Detailed Settings] tab, select [Driver Options], and then select the [Spool Data in EMF Format] check box.
- On the [Detailed Settings] tab, select [Print Quality], and then select the [Change Data Processing] check box.

### **Some characters are printed faintly or not printed.**

- In the [Select Print Quality:], select [Vivid]. If [Vivid] cannot be selected, select [Fine].
- On the [Detailed Settings] tab, select [Driver Options], and then select the [Spool Data in EMF Format] check box.
- On the [Detailed Settings] tab, select [Print Quality], and then select the [Print All Text as Black] check box.

### **Printing is slow and takes time, which delays release of the application.**

- In the [Select Print Quality:], select [Speed], and then print.
- On the [Detailed Settings] tab, select [Driver Options], and then select the [Spool Data in EMF Format] check box.

- On the [Detailed Settings] tab, select [Print Quality], and then clear the [Adjust Photographs] and [Smooth Low Resolution Images] check boxes.
- Close the resident application.

### **Printing stops halfway.**

View the Status Monitor to check whether an error has occurred.

See page 229 "Status Monitor Errors".

### **Ink smudges and characters are not properly formed when printing white text on a black background.**

In the [Select Print Quality:], select [Speed], and then print.

### **The characters printed in yellow on a black fabric are faint.**

To reproduce the detail of the image, try the following:

- Change the application you are using to print
- Edit the data
- Change the saving format you are using

---

## **Checking the Consumables**

---

If you cannot find anything wrong with the printer or printer driver, check the consumables.

### **Is an old ink cartridge being used?**

Ink cartridges should be used up before their expiry date, preferably within three months of being removed from their packaging.

### **Is a genuine ink cartridge being used?**

Using a cartridge other than a genuine ink cartridge or using a cartridge refilled with ink will lower the print quality and could cause a breakdown. Use a genuine ink cartridge.

See page 248 "Recommended Consumables".

## If a Message Appears during Installation

Message number 13, 14, 34, or 58 indicates the printer driver cannot be installed using Auto Run. Uninstall and then re-install the printer driver as follows:

Double-click the [RP\_SETUPXX.EXE] icon in the [DRIVERS] folder on the CD-ROM, and then install the printer driver according to the displayed instructions.

For details about uninstalling the printer driver, see page 203 "Uninstalling the Printer Driver".



## Error & Status Messages on the Display

This section explains what the messages that appear on the display mean and what to do when a particular message appears.

### Status Messages

Message	Status
Loading Ink... / WAIT! N minutes	Ink being filled. "N" indicates time required for this operation.
Maintenance in process...	The machine is cleaning or flushing its print head. Wait a moment.
Press Start key	Printing data was received. Press the [Start] key and start printing.
Processing...	The machine is printing.
Ready	The machine is able to print.
Resetting Job...	The machine is reinitializing a print job. Wait a moment. If the message does not disappear after a while, turn off the machine, and then turn it back on.
Setting change...	The machine is updating the network interface. Wait a moment.
Waiting...	Wait a moment.

9

### Error Messages



Message	Causes	Solutions
Adjust height, press Start to / restart or Tray to reset garment	Wrinkles, slacks or floats remain on the fabric or the edges of the fabric are protruding from the tray.	Detach the tray, and then load the fabric again. If the message reappears, adjust the height of the tray manually. See page 207 "The Tray Does Not Operate Correctly".

Message	Causes	Solutions
Adjust height, press Start to / restart or Tray to reset garment	Fabric that is 4 mm (about 0.2 inches) or thicker is loaded on the A4 standard tray or A5 tray.	Load fabric that is up to 4 mm (about 0.2 inches) thick on the A4 standard tray or A5 tray.
Auto Head Maint. Required.	Regular maintenance is needed. Usually it is displayed once every one or two weeks. Even if the frequency of use is low, it is always displayed once every four weeks.	Clean the print head nozzles.
Cannot use High Temp. / Power Off On	The temperature is abnormally high.	Check the installation area and relocate the machine. Alternatively, wait until the machine acclimates to the room temperature. See page 235 "Out of Printable Temperature Range".
Cannot use Low Temp. / Power Off On	The temperature is abnormally low.	Check the installation area and relocate the machine. Alternatively, wait until the machine acclimates to the room temperature. See page 235 "Out of Printable Temperature Range".
Clean Maint Unit Required.	Regular maintenance is needed. Usually it is displayed once every one or two weeks. Even if the frequency of use is low, it is always displayed once every four weeks.	Clean the Maintenance Unit.

Message	Causes	Solutions
Exchange Fan Filter	The number of prints that have been performed with the filter installed in the machine exceeds the maximum number (2,000).	Replace the filter, and then reset the count for the number of prints using the [Maintenance] menu. See page 188 "Replacing Filters".
Hardware Problem Ethernet Board	An error in the Ethernet port (ethernet board) network function has occurred.	Disconnect all cables, turn the machine off, and then turn it on again. If the message reappears, contact your sales or service representative. See page 236 "Network Interface Error".
Indepdnt.ink set Indepdnt.ink set / Replace Ink Crtg Indepdnt.ink set / Press # to continue	A non-genuine ink cartridge was installed.	Use of non-genuine ink cartridges or refilled ink cartridges may reduce print quality or cause malfunctions. See page 248 "Recommended Consumables".
Ink Collector is not set / Set the Ink Collector Unit	The ink collector unit is not installed or is installed incorrectly. Alternatively, an ink collector unit not meant for this machine may be installed.	Install the ink collector unit for this machine correctly. The ink collector unit meant for this machine is labeled "J089" under its handle. See page 234 "Ink Collector Unit Not Detected/Wrong Unit".
Ink Collector Unit is full / Replace Ink Collector Unit	The ink collector unit is full.	Replace the ink collector unit. See page 184 "Replacing an Ink Collector Unit".
Low Ink	The ink will soon run out.	Make sure you have a new ink cartridge for the color indicated by the  icon. See page 233 "Cartridge Almost Empty".

Message	Causes	Solutions
Maintenance failed	Head cleaning, head flushing, or other maintenance operations have failed.	Run the maintenance again after clearing the error. You can clear a maintenance error as follows: <ul style="list-style-type: none"> <li>• The machine receives another print job.</li> <li>• Press the [#Enter] key.</li> </ul>
Open Front Cover / Replace Ink Crtg	The ink has run out.	Install a new ink cartridge for the color indicated by the  or  icon. See page 178 "Replacing an Ink Cartridge".
Open Front Cover / Reset Cartridge	The ink cartridges are not installed or are installed incorrectly. Alternatively, an ink cartridge not meant for this machine may be installed.	Install the ink cartridge for this machine correctly. See page 231 "Print Cartridge(s) Not Detected/Wrong Cartridge/Cover Open".
Panel Locked Cannot use	You have pressed a locked key.	Unlock the key. See page 177 "Restricting Machine Functions".
Prepare new Ink Collector Unit	The ink collector unit is almost full.	Make sure you have a new ink collector on hand. If an ink cartridge starts running out of ink when the ink collector unit is almost full, the alert indicator will flash and a message informing you of the cartridge's low ink level will appear on the display.
Prepare new Ink& Ink Collect. Unit	The ink will soon run out and the ink collector unit is almost full.	Prepare new ink cartridges and an ink collector unit.
Press Tray key	The tray is not loaded correctly.	Detach the tray, and then load it again.

Message	Causes	Solutions
Replace Ink: ### / Press Start key for Force Print ###: Cyan, Magenta, Yellow, Black	The ink (cyan, magenta, yellow, black) will soon run out.	If you continue printing, press the [Start] key. Because the specified print setting (garment type, print quality, thickness) uses a large volume of ink, it may run out while you are printing. Prepare the ink cartridge soon.
Right Front Cover is open / Close Right Front Cover	The right front cover is open.	Close the right front cover. See page 230 "Cover Open".
Right Int. Unit almost full	Internal unit is a service replacement part.	For details about internal unit replacement, contact your sales or service representative.
SCXXX-XX Power Off On / Call Service if error reoccurs	An error has occurred.	Turn the machine off and then on. If the message reappears, contact your sales or service representative.
SC523-00 Power Off On / Call Service if error reoccurs	An error has occurred that the height position sensor cannot detect correctly.	Turn the machine off and then on. If the message appears again, clean the height position sensor referring to page 191 "Cleaning the Height Position Sensor". If this problem persists, contact your sales or service representative.
Set Tray	The tray is not loaded.	Load the tray on the tray stand.
Size Mismatch Tray to print or Stop to reset	The tray of the specified size is not set.	Change the print size. To continue printing without size mismatch, press the [Tray] key.
Temp. alert Please wait...	The machine is too hot or cold at start-up.	Wait until "Ready" appears on the display.
Top Cover open close it to / restart machine / Power Off On	The top cover is open.	Close the top cover. See page 230 "Cover Open".
Used Ink Collect Unit is set / Replace Ink Collector Unit	A used ink collector unit was installed.	Install a new ink collector unit. See page 184 "Replacing an Ink Collector Unit".

Message	Causes	Solutions
Used Ink Ctrdge / Replace Ink Crtg	A used ink cartridge was installed.	Replace the ink cartridge for the color indicated by the  or  icon. See page 178 "Replacing an Ink Cartridge".

**Note**

- If this does not eliminate the problem, contact your sales or service representative.

# Status Monitor Errors

If an error occurs with the machine, the Status Monitor displays an error message. Read the explanation about the corresponding error and check the detailed solution you can take.

---

## Status Monitor Does Not Open

---

If the Status Monitor does not open for a shared printer, refer to the following questions:

### Are the share settings correct?

- Check the share settings of the printer. The printer driver must also be installed on the client computer.
- If Windows Firewall is installed on the print server, configure exceptions in the firewall before using the Status Monitor.
  1. On Windows Firewall dialog box, click the [Exception] tab, and then select the [File and Print Sharing] check box.
  2. Click [Add Port...], make sure [TCP] is selected, and then enter "55665" in [Port number].

---

## No Response from Machine

---

Follow the procedure below to check the port settings and the connection between the machine and computer.

1. Check that the power of the machine is on.
2. Make sure that the computer and machine are properly connected using a USB cable.
3. On the [Start] menu, click [Devices and Printers].
  - For Windows 10: Right-click [Start], click [Control Panel], and then click [View devices and printers].
4. Right-click the machine icon, and then click [Printer properties].
5. Click the [Ports] tab.
6. Check that USB is selected in the [Print to the following port(s)] list.

### Note

- If you want to connect the machine to the network, check the operating environment, and then change the port setting.

---

## No Tray

---

The tray is not installed or is incorrectly installed.

Resolve the error using any of the following procedures:

- Load the tray.  
See page 88 "Loading a T-shirt in the Tray".
- Remove the tray.  
Press the [Tray] key and remove the tray, and then reset the tray.
- Cancel printing.  
See page 100 "Canceling Printing".

---

## Garment Misfeed

---

The fabric or tray is incorrectly installed. Alternatively, a fabric or foreign object may be stuck inside the machine.

Resolve the error using any of the following procedures:

- Load the fabric or tray correctly.  
See page 72 "Loading Fabrics".
- Adjust the height of the tray.  
See page 208 "Adjusting the Height of the Tray".
- Remove the fabric or foreign object.  
See page 212 "Removing a Fabric or Foreign Object by Opening the Top Cover".

---

## Garment Size Mismatch

---

The tray of the specified size or type is not loaded.

Resolve the error using any of the following procedures:

- Change the printing size.
- Cancel printing.  
See page 100 "Canceling Printing".

---

## Cover Open

---

The top or right front cover is open.

Close the cover.



If these covers are closed, open and close each of them again.

**If the top cover is open:**

1. Close the cover.

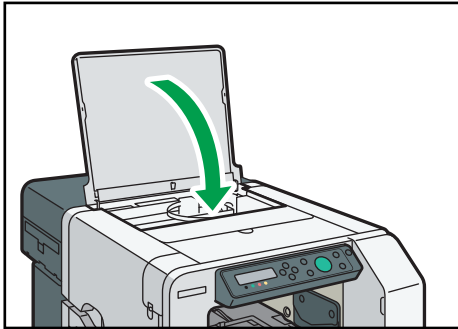

DYG028

**If the right front cover is open:**

1. Close the right front cover.

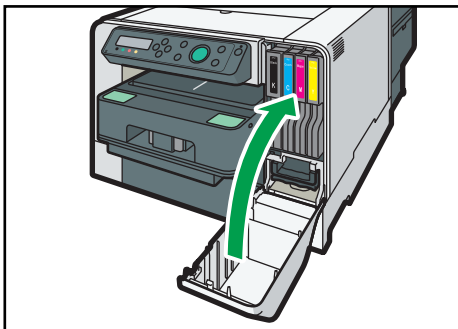

DYG059

---

## Print Cartridge(s) Not Detected/Wrong Cartridge/Cover Open

---

The ink cartridges are not installed or are incorrectly installed.

Install the ink cartridges correctly.

Alternatively, an ink cartridge not designated for this machine may have been installed.

Install an ink cartridge designated for this machine.

If the right front cover is open, close it.

If the ink cartridges are not installed or are installed incorrectly:

1. Open the right front cover.

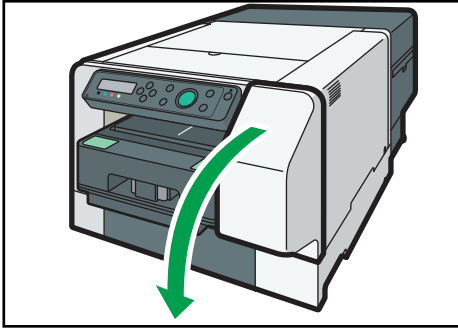

DYX030

2. Push the cartridge fully in.

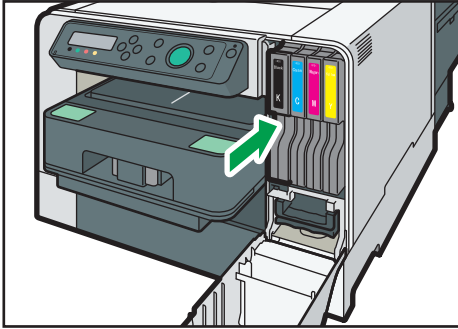

DYX052

3. Close the right front cover.

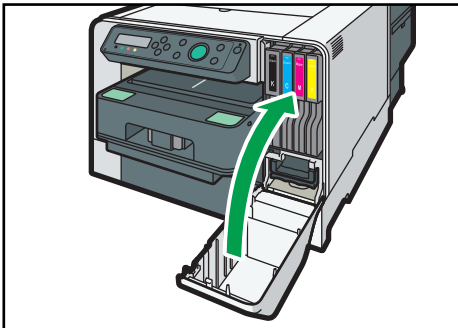

DYX059

**Note**

- If the error persists, remove the ink cartridge, and then re-install it. Do this once only.
- If there is a problem with the ink cartridge, try installing a new cartridge.
- For details about handling the ink cartridges, see page 182 "Handling Ink Cartridges".

---

## Cartridge Almost Empty

---

One of the ink cartridges is almost empty.

Check which color ink cartridge will soon have to be replaced, and then have a new cartridge handy.

### ↓ Note

- If you print an image that needs a lot of ink, the machine may stop printing before the print is finished. An example of such an image is one containing a single large area of solid color, or one made up almost entirely of a few such areas.
- Do not carry out head cleaning or head flushing. If you do, the ink may run out.
- If you turn the machine off, and then turn it on again, the machine will send the ink in the ink cartridge to the machine. During this, the ink in the ink cartridge may run out.
- The amount of remaining ink shown in the cartridge replacement indicator is for reference only and may differ from the actual amount. Also, cartridges can become empty without a low ink warning appearing.

---

## Cartridge Empty

---

The ink has run out.

Replace the cartridge.

See page 178 "Replacing an Ink Cartridge".

### ↓ Note

- If the cartridge is empty, head cleaning or flushing cannot be performed.
- If the ink runs out during printing, the machine may eject the tray while printing is performed or leave nothing printed.

---

## Used Cartridge

---

A used ink cartridge was installed.

Replace the ink cartridge.

See page 178 "Replacing an Ink Cartridge".

### ↓ Note

- If the cartridge is empty, head cleaning or flushing cannot be performed.
- Cartridges that are no longer usable for printing reserve a small quantity of ink for maintenance usage. Make sure you do not install an empty ink cartridge by mistake.

- Ink cartridges should be used up before their expiry date, preferably within three months after its package is opened.

## Ink Collector Unit Not Detected/Wrong Unit

The ink collector unit is not installed or is incorrectly installed.

Install the ink collector unit correctly.

Alternatively, an ink collector unit not designated for this machine may have been installed.

Install an ink collector unit designated for this machine.

### 1. Open the right front cover.

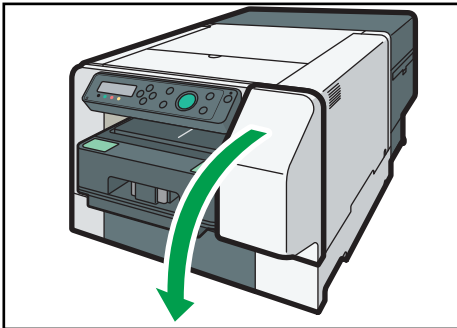

DYX030

### 2. Attach the ink collector unit by pushing it in until it clicks. Take care not to spill the ink.

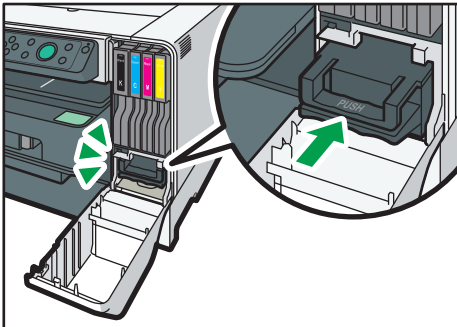

DSA324

### 3. Close the right front cover.

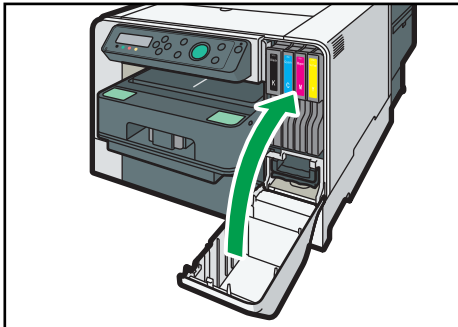

DYX059

If the message reappears, contact your sales or service representative.

---

## Ink Collector Unit Almost Full

---

The ink collector unit is almost full.

Have a new ink collector unit handy.

### ↓ Note

- If an ink cartridge starts running out of ink when the ink collector unit is almost full, the alert indicator will flash and a message informing you of the cartridge's low ink level will appear on the display.

---

## Ink Collector Unit Full

---

The ink collector unit is full.

Replace the ink collector unit.

See page 184 "Replacing an Ink Collector Unit".

---

## Used Ink Collector Unit

---

A used ink collector unit is installed.

Replace the ink collector unit.

See page 184 "Replacing an Ink Collector Unit".

---

## Out of Printable Temperature Range

---

Printing is not possible because the printer is placed in a location that is too hot or cold.

Move the machine to a more suitable environment.

1. **Press and hold down the [Power] key for one second.**
2. **Place the machine in an environment where a temperature range is between 10 and 40°C (50 and 104°F).**
3. **Turn the machine on.**

**Note**

- Even after the power is turned on, the machine may remain in standby mode until it acclimates to the room temperature. If this happens, wait until the power lamp stops flashing and stays lit.
- For details about what conditions the machine can be used under (ambient temperature and humidity range), see page 28 "Checking the Computer and Installation Area".

---

## Printer Error

---

An error has occurred in the machine.

Turn the machine off, and then turn it on again.

**Note**

- If the error still does not clear after the power is turned back on, contact your sales or service representative.

---

## Network Interface Error

---

An error in the Ethernet port network function has occurred.

Turn the machine off, and then turn it on again.

**Note**

- If the message reappears, contact your sales or service representative.

---

## Maintenance Failed

---

Head cleaning, head flushing, or other maintenance operations have failed.

Run the maintenance again after clearing the error.

You can clear a maintenance error as follows:

- The machine receives another print job.
- Press the [#Enter] key.

---

## Cannot Recover Error Page

---

If you resume printing after resetting the garment misfeed error or other errors, printing may not be correctly performed and a message appears.

Depending on the printing result, resolve the error using any of the following procedures:

### If Nothing Printed

If the tray is not automatically ejected, press the [Tray] key and move the tray stand to the front.

Remove the tray and reload the fabric correctly. After reloading the tray, press the [Start] key to resume printing.

If printing does not start, adjust the height of the tray, and then press the [Start] key.

See page 72 "Loading Fabrics", page 208 "Adjusting the Height of the Tray".

### If Partially Printed

Cancel printing.

See page 100 "Canceling Printing".





# 10. Appendix

---

## Software on the CD-ROM

---

### Files

---

The following is a list of the files on the CD-ROM.

#### For Windows

- RPCS Raster Printer Driver for Windows Vista/7/8.1/10 and Windows Server 2008/2008 R2/2012/2012 R2/2016
- WebImageMonitor Help
- Manuals
- Tools to acquire computer information
- Design Software
- ICM Color Profiles for Printer
- Install Manager
- SETUP.EXE
- OSS.PDF

#### For Macintosh

- RPCS raster printer driver for Mac OS X 10.8 or later
- WebImageMonitor Help
- Manuals
- Design Software
- OSS.PDF

---

### RPCS Raster Printer Drivers

---

This section gives the file locations of the different RPCS raster printer drivers and their system requirements.

#### File Location

The drivers are in the following folders on the supplied CD-ROM.

- RPCS raster printer driver for the 32-bit Windows  
DRIVERS\X86\RPCS\_R\X86\disk1
- RPCS raster printer driver for the 64-bit Windows

DRIVERS\X64\RPCS\_R\X64\disk1

- RPCS raster printer driver for Mac OS X  
macOS\RPCS\_R

### System Requirements for the Printer Drivers

- Operating Systems  
Windows: Windows Vista/7/8.1/10 and Windows Server 2008/2008 R2/2012/2012 R2/2016  
Macintosh: Mac OS X 10.8 and later versions
- Display Resolution  
Conforms to the system requirements of each operating system.

#### Note

- In a cluster configuration environment, you cannot autorun the printer driver install.
- For details about using the printer driver, see the printer driver Help.
- The printer drivers do not support clustering technology under Windows Server 2008/2008 R2.

---

## Manuals

---

This section gives the location of the manuals.

### File Location

The manuals are in the following folders on the supplied CD-ROM.

MANUAL\_PDF

# Electromagnetic Interference



If another electronic device is placed next to the machine, each will influence the other negatively. In the case of a television or radio, noise may be generated. If this happens, do the following:



- Move the television or radio as far as possible from the machine.
- Change the position of the antenna of the television or radio.
- Use a different wall outlet on a different circuit.



# Specifications



Specifications of the machine and options are listed.

## Machine Body

Item		
Print method	GELJET print technology	
Print time	<ul style="list-style-type: none"> <li>• Full color 74 seconds (after pressing the [Start] key)</li> <li>• B&amp;W 72 seconds (after pressing the [Start] key)</li> </ul>	
Print resolution	Max 1200 × 1200 dpi equivalent	
Nozzles	Black: 192 nozzles Cyan, magenta, and yellow: 192 nozzles per color	
Warm-up time	21 seconds	
Tray type	A4 standard tray	<ul style="list-style-type: none"> <li>• Printable area 291 × 204 mm (11.5 × 8.0 inches)</li> </ul>
	A5 tray	<ul style="list-style-type: none"> <li>• Printable area 204 × 142 mm (8.0 × 5.6 inches)</li> </ul>
	Sleeve & Socks Tray	<ul style="list-style-type: none"> <li>• Printable area 204 × 142 mm (8.0 × 5.6 inches)</li> </ul>
Fabric thickness	7 mm (0.27 inches)	
Number of loadable trays	1 tray	
Power source	 <b>Region A</b> (mainly Europe, Asia, and China) 220-240 V: 50/60 Hz 0.6 A (when fully equipped)  <b>Region B</b> (mainly North America) 100-120 V: 60 Hz 1 A (when fully equipped)	

Item			
Power consumption <sup>*1</sup>	Main unit only	Ready	<p> <b>Region A</b> (mainly Europe, Asia, and China) 9.6 W</p> <p> <b>Region B</b> (mainly North America) 9.8 W</p>
		During printing	<p> <b>Region A</b> (mainly Europe, Asia, and China) 31.2 W</p> <p> <b>Region B</b> (mainly North America) 30.9 W</p>
		Maximum	<p> <b>Region A</b> (mainly Europe, Asia, and China) 47 W</p> <p> <b>Region B</b> (mainly North America) 47 W</p>
Power consumption <sup>*1</sup>	Complete system	Maximum	<p> <b>Region A</b> (mainly Europe, Asia, and China) 47 W</p> <p> <b>Region B</b> (mainly North America) 47 W</p>

Item		
Energy Saver mode	Reduced power consumption in Energy Saver mode *2	 <b>Region A</b> (mainly Europe, Asia, and China) 1.8 W  <b>Region B</b> (mainly North America) 1.7 W
	Time of switch into Energy Saver mode	5 minutes
	Time of switch out from Energy Saver mode *2	2.9 seconds
Operating environment	Temperature: 15 to 32 °C (59 to 89.6 °F) Humidity: 15-80% RH Printing may stop to protect the machine for conditions outside those described above.	
Storage environment	Temperature: 10 to 40 °C (50 to 104 °F) Humidity: 5-90% RH	
External dimensions	(W × D × H) 399 × 682.8 × 292.5 mm (15.7 × 26.9 × 11.5 inches) (standby) (W × D × H) 399 × 760.3 × 292.5 mm (15.7 × 29.9 × 11.5 inches) (during operating)	
Weight	Approx. 34 kg (75.0 lb.) (when packaged) Approx. 24 kg (53.0 lb.) (machine and tray) Approx. 21 kg (46.3 lb.) (machine)	
Interface	USB 2.0 high speed Ethernet (10BASE-T, 100BASE-TX) Wireless LAN (IEEE 802.11 b/g/n)	

Item		
Wireless LAN	Transmission Specification	Based on IEEE 802.11b/g/n
	Data Transfer Speed	Auto select from the following speed: <ul style="list-style-type: none"> <li>• 802.11b 1, 2, 5.5, 11 (Mbps)</li> <li>• 802.11g 6, 9, 12, 18, 24, 36, 48, 54 (Mbps)</li> <li>• 802.11n 6.5, 7.2, 13, 13.5, 14.4, 15, 19.5, 21.7, 26, 27, 28.9, 30, 39, 40.5, 43.3, 45, 52, 54, 57.8, 58.5, 60, 65, 72.2, 81, 90, 108, 120, 121.5, 135, 150 (Mbps)</li> </ul>
	Frequency Range	 <b>Region A</b> (mainly Europe, Asia, and China) 2412 to 2472 Mhz (1 to 13 Channels)  <b>Region B</b> (mainly North America) 2412 to 2462 Mhz (1 to 11 Channels)
	Transmission Mode	Infrastructure mode
Printer language	RPCS Raster	

\*1 To avoid any power consumption, disconnect the power plug from the wall outlet. (Unplug the power plug only after making sure the power lamp is off.) Power Consumption may differ depending on the conditions and environment of the machine.

\*2 The time it takes to switch out from energy saving functions and power consumption may differ depending on the conditions and environment of the machine.

## Optional Trays

Item	
External dimensions	<ul style="list-style-type: none"> <li>• A5 tray (W × D × H) 242.2 × 409.2 × 97.9 mm (9.5 × 16.1 × 3.9 inches)</li> <li>• Sleeve &amp; Socks Tray (W × D × H) 242.2 × 409.2 × 97.9 mm (9.5 × 16.1 × 3.9 inches)</li> </ul>

Item	
Weight	<ul style="list-style-type: none"><li data-bbox="454 309 728 393">• A5 tray Approx. 2.6 kg (5.8 lb.)</li><li data-bbox="454 407 728 491">• Sleeve &amp; Socks Tray Approx. 2.4 kg (5.3 lb.)</li></ul>



# Where to Inquire

For inquiries, contact your sales or service representative.

## Recommended Consumables

Consumables recommended for this machine are listed.

Purchase necessary consumables before your supply runs out.

For information about consumables, contact your sales or service representative.

- Ink cartridges
- Ink Collector Unit
- Cleaning cartridge
- Cleaning tool
- Absorbent
- Cleaning stick
- Cleaning liquid
- Filter

# Options and Consumables

## **RICOH Tray for Small Size Type 1**

This tray is for printing within an A5 size area on a fabric.

## **RICOH Tray for Sleeve & Socks Type 1**

This tray is for printing on sleeve or socks.

### **Note**

- For information about options and consumables, contact your sales or service representative.

# Trademarks

Apple, AppleTalk, Bonjour, ColorSync, Leopard, Macintosh, Mac OS, OS X, iMac, MacBook, Mac mini, Power Mac, Safari and TrueType are trademarks of Apple Inc., registered in the United States and other countries.

Citrix, Citrix Presentation Server and Citrix XenApp are either registered trademarks or trademarks of Citrix Systems, Inc.

Firefox® is a registered trademark of the Mozilla Foundation.

Intel and Intel Core are registered trademarks of Intel Corporation or its subsidiaries in the United States and other countries.

Microsoft®, Windows®, Windows Server®, Windows Vista®, and Internet Explorer® are either registered trademarks or trademarks of Microsoft Corporation in the United States and/or other countries.

Monotype is a registered trademark of Monotype Imaging Inc.

PowerPC® is a registered trademark of International Business Machines Corporation in the United States and other countries, or both.

UNIX is a registered trademark in the United States and other countries, licensed exclusively through, X/Open Company Limited.

The proper name of Internet Explorer 6 is Microsoft® Internet Explorer® 6.

The proper names of the Windows operating systems are as follows:

- The product names of Windows Vista are as follows:

Microsoft® Windows Vista® Ultimate

Microsoft® Windows Vista® Business

Microsoft® Windows Vista® Home Premium

Microsoft® Windows Vista® Home Basic

Microsoft® Windows Vista® Enterprise

- The product names of Windows 7 are as follows:

Microsoft® Windows® 7 Home Premium

Microsoft® Windows® 7 Professional

Microsoft® Windows® 7 Ultimate

Microsoft® Windows® 7 Enterprise

- The product names of Windows 8.1 are as follows:

Microsoft® Windows® 8.1

Microsoft® Windows® 8.1 Pro

Microsoft® Windows® 8.1 Enterprise

- The product names of Windows 10 are as follows:
  - Microsoft® Windows® 10 Home
  - Microsoft® Windows® 10 Pro
  - Microsoft® Windows® 10 Enterprise
  - Microsoft® Windows® 10 Education
- The product names of Windows Server 2008 are as follows:
  - Microsoft® Windows Server® 2008 Standard
  - Microsoft® Windows Server® 2008 Enterprise
- The product names of Windows Server 2008 R2 are as follows:
  - Microsoft® Windows Server® 2008 R2 Standard
  - Microsoft® Windows Server® 2008 R2 Enterprise
- The product names of Windows Server 2012 are as follows:
  - Microsoft® Windows Server® 2012 Foundation
  - Microsoft® Windows Server® 2012 Essentials
  - Microsoft® Windows Server® 2012 Standard
- The product names of Windows Server 2012 R2 are as follows:
  - Microsoft® Windows Server® 2012 R2 Foundation
  - Microsoft® Windows Server® 2012 R2 Essentials
  - Microsoft® Windows Server® 2012 R2 Standard
- The product names of Windows Server 2016 are as follows:
  - Microsoft® Windows Server® 2016 Datacenter
  - Microsoft® Windows Server® 2016 Standard
  - Microsoft® Windows Server® 2016 Essentials
  - Microsoft® Windows Server® 2016 MultiPoint Premium

Other product names used herein are for identification purposes only and might be trademarks of their respective companies. We disclaim any and all rights to those marks.

Microsoft product screen shots reprinted with permission from Microsoft Corporation.



# INDEX

## A

Active Protocol.....	142
Adjust Height keys.....	21
Alert indicator.....	20
Auto Head Maint.....	114

## C

Canceling printing.....	100
Cartridge replacement indicator.....	21
Clean Internals.....	114
Clean Maint Unit.....	114
Color Demo Page.....	111
Config. Page.....	111
Connect. Status.....	143
Counter.....	108
Cover.....	17, 18, 19

## D

Date/Time.....	113
DHCP.....	141
DHCPv6.....	141
Display.....	20
Display Job Name.....	138
Display Version.....	138
Domain Name.....	140

## E

Easy Setup.....	144
Energy Saver.....	137
Enter key.....	20
Error Log.....	111
Error Messages on the Status Monitor.....	229
Escape key.....	20
Ethernet port.....	16
Ethernet Speed.....	142

## F

Fabric.....	70
Fan Filter.....	114
Fan Speed.....	114
Feed Test.....	113
Filter.....	16
Fixing Ink.....	94

## H

Head Position.....	113
Head-cleaning.....	113
Head-flushing.....	113
Height Adjust.....	114
Host Interface.....	140
Host Name.....	140

## I

I/O Timeout.....	140
Img Recov. Error.....	138
Indentations for Lifting.....	16
Ink C.U. Space.....	138
IPsec.....	142
IPv4 Address.....	141
IPv4 DDNS.....	140
IPv4 DNS.....	140
IPv4 Gateway.Ad.....	141
IPv4 Subnet M.....	141
IPv6 Address.....	142
IPv6 DDNS.....	141
IPv6 DNS.....	141
IPv6 Gateway.Ad.....	142
IPv6 Statlss Ad.....	142

## K

Key Repeat.....	113
-----------------	-----

## L

Language.....	146
List/Test Print.....	111
Loading and removing the tray.....	22
Loading and Removing the Tray.....	22
Loading fabrics.....	72

## M

MAC Address.....	142, 144
Machine Name.....	140
Maintenance.....	113
Manual Pocket.....	17
Menu key.....	20
Messages on the display.....	223
Move Print-Heads.....	113

---

## N

Network connection.....	50
Network Setup.....	140
No-Fuss Head Cleaning.....	21
Notify by Email.....	137
Nozzle Check.....	113

## P

Pmt SSL/TLS Com.....	143
Port Setting.....	144
Power cover.....	16
Power inlet.....	16
Power key.....	21
Power lamp.....	20
Print.....	108
Printer driver.....	98
Printer Version.....	138
Prmt SNMPv3 Com.....	143

## R

Rear Cover.....	15
Registration.....	113
Removing dust/flattening fibers.....	87
Replacing an ink cartridge.....	178
Restore Default.....	143
Right Front Cover.....	16

## S

Security Method.....	144
Show Counter.....	108
SSID.....	143
Start key.....	20
Status Monitor.....	147
Stop key.....	21
System.....	137

## T

Table.....	17, 18, 19
Top Cover.....	15
Tray (A4 Standard Tray).....	17
Tray (A5 Tray).....	18
Tray (Sleeve & Socks Tray).....	18
Tray key.....	20
Tray Positioning Line.....	17, 18, 19

Tray Stand.....	16
-----------------	----

## U

Uni-direct.Prt.....	137
Unit of Measure.....	137
Unlock Button.....	17, 18, 19
USB connection.....	43
USB port.....	16
USB Setting.....	144
USB Speed.....	144

## V

Vent.....	15
-----------	----

## W

Waste ink full indicator.....	21
Web Image Monitor.....	148
Wireless LAN.....	143
Wireless LAN cable.....	16
WLAN Version.....	138
Wrless Sig Stat.....	143



---

MEMO

---

MEMO



